

PINZE PREMISTOFFA

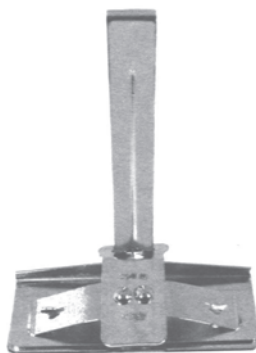

A967J20
pinza a balestra cm.20



A967J15
pinza a balestra cm.15

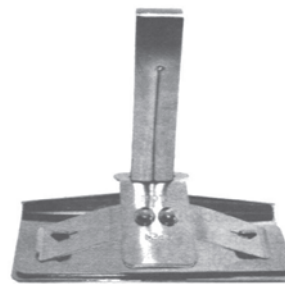

A967J10
pinza a balestra cm.10



A968 a colonna in alluminio
cm.10



A967
cm.20

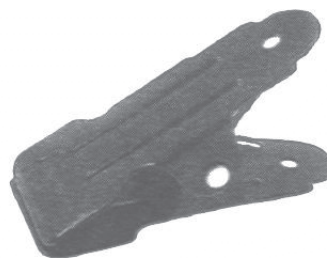

A969/4
pinza a molla cm.4

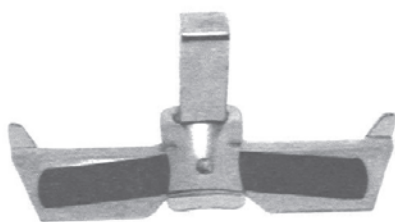

A971 pinza a balestra cm.4

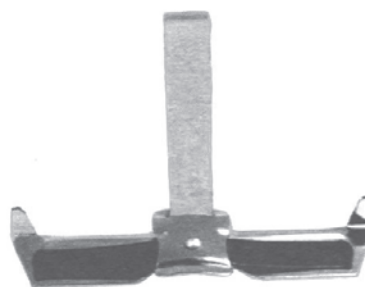

A972 pinza a balestra cm.6

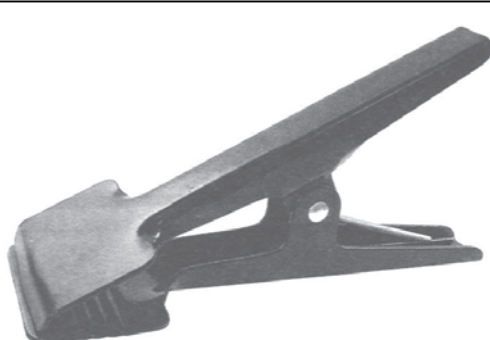

A970 pinza a molla cm.12

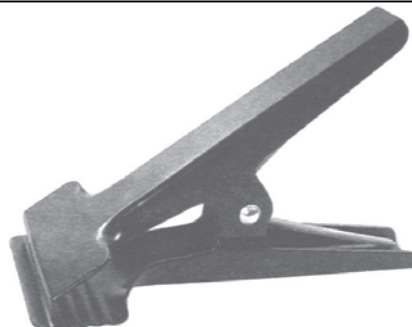

A969 pinza a molla cm.6

Modello "DABO" nera: **A970B** cm. 12 - **A969B** cm. 9 - **A969B6** cm. 6

ACCESSORI



A2320J trapanino elicoidale correato di
5 fustelle mm.1,5/2/3/4/5
A2320JF fustelle ricambio



A2320 Trapanino ZENITH
A2320F Fustelle mm. 3/4/5



A1145 pinza per tacche USA 1/16x5/16
A1146 USA 1/8x5/16
A1145J50N economica 1/16x5/16
A1145J45N " 1/16x1/4
A1146J " 1/8x5/16



A2231 fustellatore per modelli
diametro foro mm.19



A2235 torchietto
Per bottoni a pressione



A1147
gancio extra con corda



A1148
gancio rigido



A1149
gancio rigido



A1145C apparecchio
segna tacche a colonna



A1044
rotella marcatrice



A1070 staffa a muro
per modelli e ganci



A1044BIS rotella marcatrice
con punta a spillo

ACCESSORI



A1150

Prim/Aida
Scat.blu 6/7/8
mm.30/32/34
Gr.500 Acciaio lucido

A1150NO/250

INFLEX scat.rossa acciaio nichelato
misure 6/7/8 mm.30/32/34
gr.250

A1150NO

mm.30/32/34
gr.500

A1150B16

pallina testa vetro
conf. Magnetica
gr.16 (200 spilli)

A1150B8

pallina testa vetro
mm.30x0,6 gr.8



A1150NO1

Spilli INFLEX kg.1
Mis.6/7/8 mm.30/32/34
Acciaio nichelato

A1150B6

spilli Leone Kg.1
mis.25 = mm.24
ottone nichelato

A1150/30

pallina testa vetro
mm.48x0,8 gr.30

A1150B18

spilli Leone testa vetro
mm.50x0,8 gr.50



Spilli e aghi a mano

ECONOMICI

Bustine da 25 pz

AVB7/1 mm.49
AVB7/2 mm.47
AVB7/3 mm.44
AVB7/4 mm.42
AVB7/5 mm.40
AVB7/6 mm.38
AVB7/7 mm.36
AVB7/8 mm.35

MILWARD

bustine da 20 pz

AVB/MIL3 mm 44
AVB/MIL4 mm 42
AVB/MIL5 mm 40
AVB/MIL6 mm 38
AVB/MIL7 mm 36
AVB/MIL8 mm 35
AVB/MIL9 mm 34
AVB/MIL10 mm 32
AVB/MIL12 mm 27

PER LANA

bustine da 25 pz

AVB30/14 mm 63
AVB30/16 mm 55
AVB30/18 mm 47
AVB30/20 mm 41
AVB30/22 mm 35

TAIFUN

tubetti da 25 pz.

AVB/TAI3 mm 44
AVB/TAI4 mm 42
AVB/TAI5 mm 40
AVB/TAI6 mm 38
AVB/TAI7 mm 36
AVB/TAI9 mm 34
AVB/TAI11 mm 29

ACCESSORI

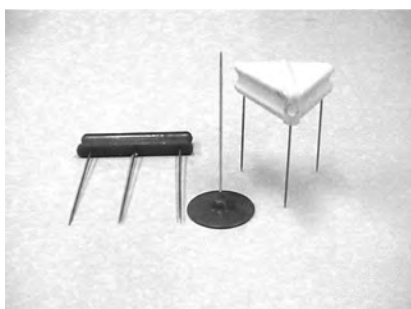

A2321B a 3 spilli piatto
A2321A a 3 spilli triangolo
A2322 1 spillo base tonda



A1136
 impugnatura per lame usate



A2325 punteruoli in legno
A2325P in plastica



A1042AD centimetri adesivi
A1042ADA contrari /arancio



A1042
 metri per sarto standard



A1042P centimetri/pollici
A1042MM centimetri millimetrati
 bianchi in fiberglass



A1042BIS
 centimetro avvolgibile
 cm.150



A2326
 allaccia bottoni



A2327
 segnaorli



AV122 manichino regolabile uomo
AV123 manichino regolabile donna
AV123M manichino donna maggiorato
AV123V vestito per manichino



A2317G gessatore Swiss
A2317GJ gessatore economico

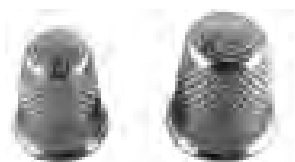

AV DITALE/15 ditale donna in mm.
AV DITALE/16
AV DITALE/16,5
AV DITALE/17
AV DITALE/18
AV DITALE/19

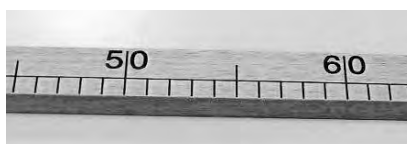

A1042L
 Metro da banco
 In legno



A2332/50
A2332/60
A2332/70
 Curvilinee in
 Plexiglas trasparente

ACCESSORI

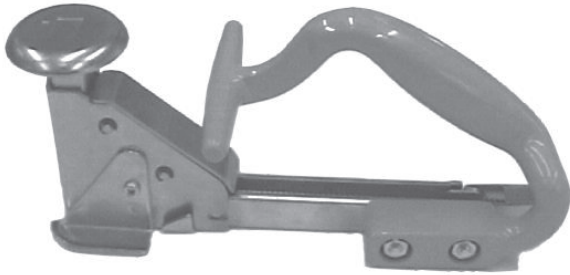

A1125
graffatrice **BATES**



A1125NAZ
graffatrice **PRATIC P19**
prod.nazionale in fibra antishock
(vedi esploso per ricambi)



Punti metallici aperti universali
Perfezionati per non danneggiare
i tessuti

delle migliori produzioni nazionali

A1126NO	7mm
A1127NO	10mm
A1128NO	13mm

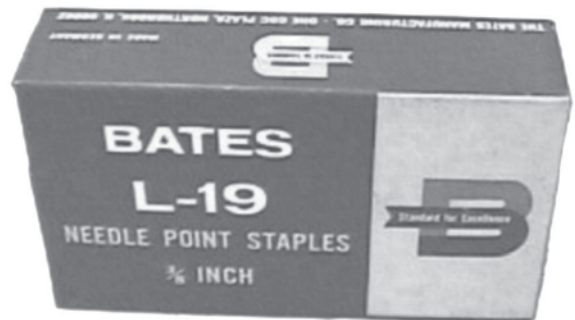

Versione originale Bates

A1126	7mm
A1127	10mm
A1128	13mm

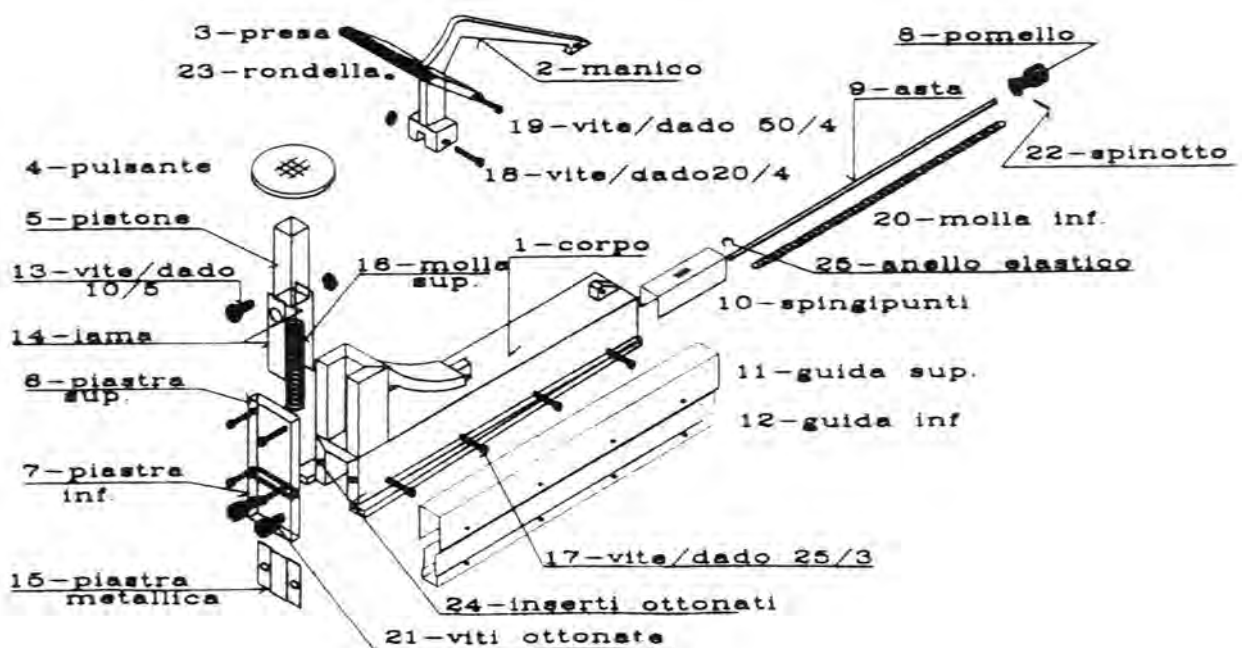

ACCESSORI



A1126A-6 A1127A-8
punti per Bates "ANKER"



A1125RAPID
graffatrice



A1126L (43/6)A1127L (43/8)
punti per graffatrice RAPID



A2313B matite in grafite bianche
A2313N matite in grafite nere
(ex CONTE')



A2313BA matite acquarellabili
A2313NA matite acquarellabili
bianche BA – nere NA



Matite dermatografiche autoaffilanti
A2313D bianche
A2313DA colorate (specificare col.)
nero-blu-giallo-rosso-verde

Pennarelli evanescenti

Per un uso corretto,seguite le istruzioni sotto indicate



A1142/44 pennarello evanescente viola + cancellatore
A1142R/44 pennarello evanescente rosa + cancellatore

A1142 pennarello evanescente VIOLA
A1142R pennarello evanescente ROSA
A1142B pennarello evanescente BLU (idrosolubile)
A1143 pennarello evanescente BIANCO

A1144 pennarello cancellatore

RICORDIAMO CHE:

La traccia svanisce da sola in tempi da 1 a 14 gg secondo il colore, escluso il BLU che è cancellabile solo con acqua. Svaniscono tutti con lavaggio ad acqua – solo ROSA e VIOLA possono essere cancellati con il cancellatore. Il BIANCO può essere cancellato anche con lo stiro.



A1142UVA
Pennarelli evidenziabili con luce UV



A1142UVAM
matite con mine intercambiabili UV



A973JLAMPUV
lampadine UV per lampade neon
A973JCPL o A973J2 vedi pag.85

ACCESSORI

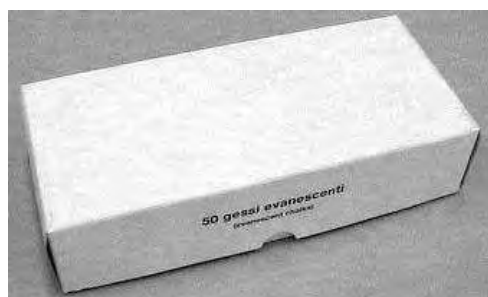

A2304 gessi cera colore x100pz
A2305 " bianco x100pz

A2307 gessi in argilla (caolino) bianchi
A2310 gessi in argilla (caolino) colorati
A2308 gessi in argilla (caolino) assortiti
 Scat.x 100 pz.

A2306
 gessi evanescenti scat.x 50 pz.



A2306BIS
 Gessi evanescenti atossici
 (PUCK) con fascetta gialla
 (conf. x 35 pz)

A2309 matite cera bianco A51
A2311 matite cera colore x100pz.

A2303C
 Affilagessi in plastica
A2303B
 Affilagessi a lamette



A2308/10
 Gessi col.assortiti 10pz.
A2307/10 bianchi

A2313R
 Refil argento per pelle 10pz.

A2317 bianco **A2319** colorato
 Gesso in polvere conf.1Kg
 per segna orli vedi art. **A2327**

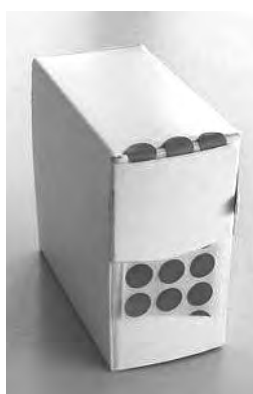

A3022 mm.10
 bollini segnafalli adesivi bianchi e colorati
 colori disponibili : **Bianco - Rosso - Giallo - Verde - Celeste - Arancio - Nero**

A3023 mm.15
 bollini segnafalli adesivi bianchi e colorati

ACCESSORI

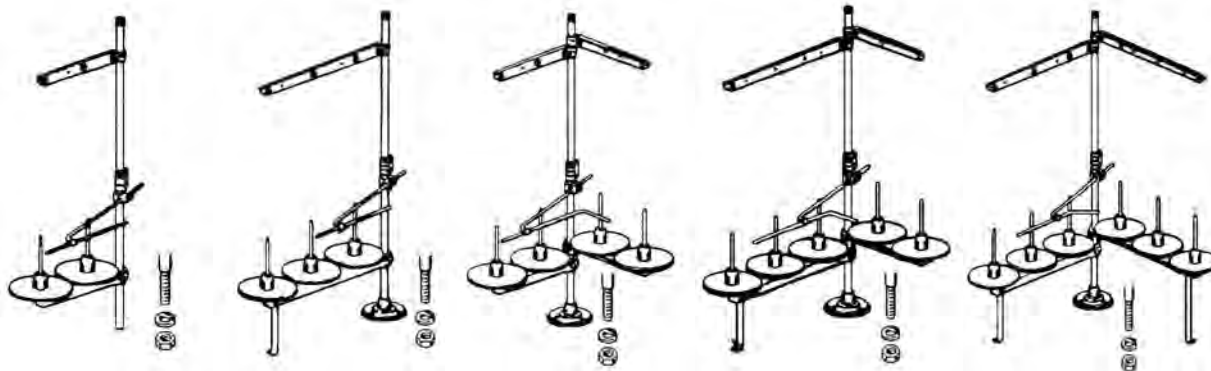

K2 **K3** **K4** **K5** **K6**
 Portaspole con passafilo superiore , in metallo verniciato BEIGE - versione identica al modello Mauser / W&G

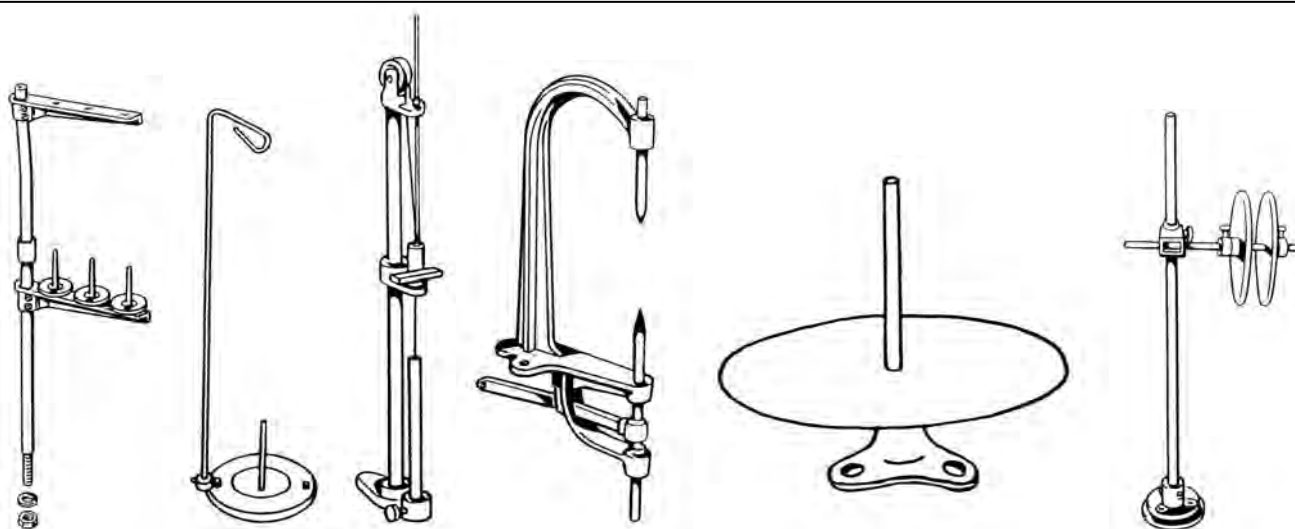

A962 **A958** **A965** **A966** **A963** **A964**
 3 fili eco. per attaccabottoni voltacinture voltacolli portarotolo orizzontale metallo portarotolo verticale



A963Y portarotolo con tensione **A964/TS4** portarotolo posizionabile

ACCESSORI

ETICHETTATRICI



A3016 etichettatrice progressiva OPEN/BLITZ 2653
A3016-22x12 stesso modello per etichette 22x12



A3016K3P etichettatrice TOVEL progressiva 26x12
 5 caratteri fissi e 3 progressivi

A3016W3P etichettatrice TOVEL progressiva 26x16
 10 caratteri fissi più 8 con 3 progressivi

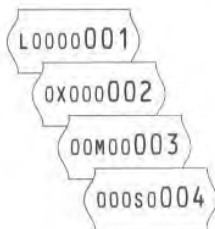

ETICHETTE:

A3017 sagomate 26x12 permanente
A3017C sagomate 26x12 permanente colorate
A3017REM sagomate 26x12 removibili
A3017FORTE sagomate 26x12 forte (adesivo 4)
A3017ANTI sagomate 26x12-26x16 antimacchia
A3017/22x12 22x12 permanente
A3017/22x12C 22x12 permanente colorate
A3017/26x16 sagomate 26x16 permanente
A3017/26x16R rettangolari 26x16 permanente
A3017/26x16RRE rettangolari 26x16 removibili
A3017/26x16RRC rettangolari 26x16 removibili colorate

TAMPONCINI RICAMBIO

A3018 BLITZ/OPEN
A3018PROG PRINTEX
A3020 PRIX STARTER
A3020/E101 PRIX E101
A3020M METO (C1)
A3021 TOVEL K3P-W3P
A3021/TG TOVEL TG
A3021/TK TOVEL TK
A3021/TP3 TOVEL TP3



PISTOLE ARROW SMACCHIATICI (ce)



A3000YH170



A3000YH120



A1082
 Smacchiatore liquido
 non infiammabile e
 conforme alle normative.
 Nuova prod. ottimizzata
 SEVEN200 x 10 lt.
A1082/25 taniche da 25 lt.
A1091 Pulimak,
 smacchiatore spray a secco

A3000YH120AD
 Con getto aria asciugatore



ACCESSORI



A993 guida a T



A990 guida tripla



A2300 guida a rullo sganciabile



A992 guida sganciabile



A994 guida a scatto per camciera



A995 guida a scatto con rullo per pelle

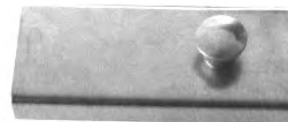

A989 guida magnetica



A988 guida magnetica



A988S guida magnetica piccola



A989G guida magnetica grande



A989GS piccola

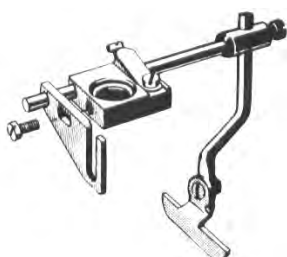

A1016JU-9 foro mm.9 x Singer ecc.
A1016JU foro mm. 11,5 per Juki
A1016DU212 foro mm.13,1 per DK
A1016PF foro mm.14 per Pfaff



A1016DJU-9 doppia x Singer
A1016DJU doppia x Juki
A1016D/DU212 doppia x DK
A1016DPF doppia x Pfaff



A1016-S570
 guida doppia per piedini
 con attacco piatto :
 Brother-Juki-Singer-Durkopp ecc.



A1007 guida doppia mm.9 x Singer ecc.
A1008 guida doppia mm.14 x Pfaff
A1009 guida doppia mm.11 x Juki-Dk
A1009/11,5 guida doppia mm11,5 x Juki



A1004
 guida sganciabile PF 463 mm.14
A1004/9
 guida sganciabile mm.9



A1016 guida universale destra
A1016S guida universale sinistra
A1016/1 astine di ricambio

ACCESSORI



A1016ECO1

Guide sganciabili per piedini domestici

A1016ECO2



A1601

salvadito per lineari



83239

salvadito univ. 1 ago



A1603

union-singer 1 ago



A1604

Singer 107W



A1605

Singer 112W-212W



A1606

per 2 aghi att.piatto



A1607

Singer 108W-111W
211G-211W



B150384

lineari Brother



A1003/1

Rasafilo in plastica



A1003

rasafilo a molla



A1003P

a molla inclinato

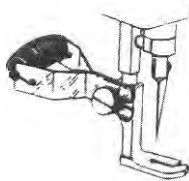

A1002

rasafilo per placche ago



ACCESSORI



A3000TA Taggy ago standard (S)
A3000TAF Taggy ago fine (X)

A3000B Banok standard **A3000BF** Banok fine
A3000BL Banok ago lungo



A3000 Arrow economica standard (S)
A3000FINE versione ad ago fine (X)
A3000L versione con ago lungo

A3000D Dennison Avery

- 1 Housing
- 2 Housing Cover
- 3 Needle Lock
- 4 Free Lever
- 5 Outent
- 6 Feed Finger
- 7 Sprocker
- 8 Shifter Regular Long
- 9 Ejector Rori
- 10 Lever
- 11 Slider Assembly
- 12 Slider
- 13 Randle
- 14 Needle Cop
- 15 Sprocker Cover
- 16 Cutter
- 17 Fix Spring
- 18 Coil Spring
- 19 Handle & Pin
(M3 x 21,3)
- 20 Roller
(M4 x 21,2)
- 21 Screw (M2,5 x 10)

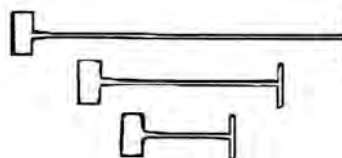
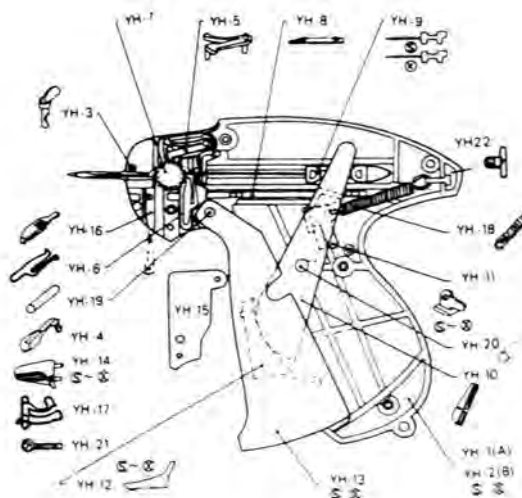

A3001 ago standard Arrow
A3001F ago fine Arrow
A3001L ago lungo Arrow
A3001B Banok orig.standard
A3001BF Banok orig.fine
A3001BL Banok orig.lungo
A3001D Dennison standard
A3001DF Dennison fine

A3001T Taggy standard
A3001TF Taggy fine

A3002 **A3002FINE**
fili naylor standard (S) fili naylor fini (X)
misure disponibili mm.
standard: 15,20,25,40,45,50,65,70,75,130
fine: 7,11,15,20,25,45,50,65,75
(fili colorati a richiesta)
A3002/7FINEBK 7mm. Fine originale Banok
(originali Banok/Dennison altre misure a richiesta)
A3002S fili di sicureza mm. 75, 125, 130, 225

ACCESSORI



A3015
spazzola velluto unidirezionale



A3014 ricambio per pulirella
A3013ER ricambio per "Economica"
A3013RE ricambio per "Risparmio"



A3013 rullo adesivo pulirella super
A3013E rullo adesivo Economico
A3013R rullo adesivo Risparmio



A1135
portarocchettini kriko

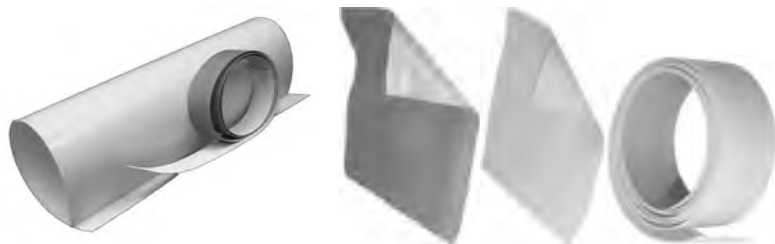

A1200AD foglio teflon adesivo 30x30 mm 0,5-0,8
A1200JAD rotolo teflon adesivo da 1 mt x mm.0,2
A1200J rotolo teflon cementato 124x25 x0,5-1-1,5
A1200JADB rotolo teflon adesivo 100x25x0,6
A1200 foglio teflon NON adesivo 30x30x1,5



A1082 smacchiatore liquido nuova formula Seven 300 , taniche x 10 lt.
A1082/25 taniche da 25 lt.
A1091 Pulimak / smacchiatore a secco



A2000EC-10A



A2000K forbice elettrica con accumulatore ricaricabile. per campioni o modelli
A2000KR testine ricambio



A2000EC1A



A2000EC1C



A2000EC1B



A2000EC1S



A2000EC10



A2000EC12

A2000EC-10A forbice elettrica con accumulatore ricaricabile. per campioni o modelli (completa)
A2000EC10 testine ricambio
A2000EC12 testine con base d'appoggio
A2000EC1B batteria ricambio
A2000EC1S batteria con presa jack alimentatore per uso continuo
A2000EC1A alimentatore

ACCESSORI



A3500
Piastra per termoadesivi
termostato regolabile
75x15 1600W 220V.



Pesi fermatessuto **A1060** Kg.1
A1061 Kg.1,700
A1062 Kg.3,400
A1063 Kg.7



A1058
levapelucchi a batteria

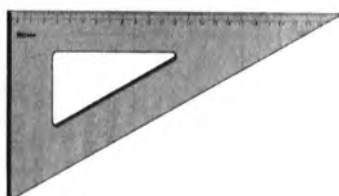

A2330 / 32-40-50-60
Squadre millimetriche in alluminio



A2331 / 100-125-150
Righe millimetriche in alluminio



A2332/50 /60 /70
curvilinea in plexiglass trasparente



R991186
canalina Rimoldi



J118-50054
canalina Juki



MS205468-69-70 (=KX10-12-13)
canalina W&G = Siruba/Mauser



A3010
contapezzi



JT035TIR
tiranti pneumatici a 1 e 2 vie per aspiracat.e alzapiedino



JT035TIR2

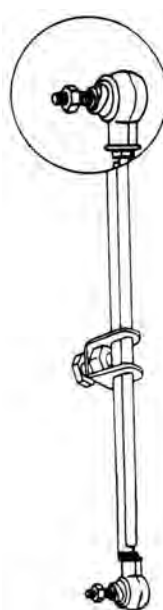

A2232
tirante semplice



A1133 polvere detergente
per piastre termoadesive e
ferri da stiro

A1082PN detergente per
nastri termoadesivatrici
liquido. Tanichetta da 5 lt.

A1082PNS
versione spray
A1082PNP
versione in polvere

ACCESSORI



Pinza taglia-fora cinghia
A977 piccola x mm 4/5
A978 grande x mm 6/8
A977F- A978F fustelle ricambio
A977C- A978C coltello ricambio

A979 - 5 / 6 / 7 / 8 / 9
 cinghia cuoio – rotoli x 25 mt.
A979
 spezzoni tagliati 5x190

A979P8
 Cinghia in poliuretano
 arancione indeformabile
 rotoli da mt.32 mm.8

A979P8CONN
 connettori ricambio
A1031-4/5/6/7/8
 ganci per cinghia di cuoio



Filo abrasivo **MITCHELL'S**
A984-54/0,76 **A986-53/1,02**
A985-52/1,4 **A986-55/0,46**
A986-50/1,78 **A986-56/2,4**
A986-49/2,08 **A986-57/3,18**
A986-51/1,4 **A986-48/2,36**
A986-60/0,38 **A986-66/0,31**

A1000 Tela smeriglio fogli grana da 100 a 280
A999 tela smeriglio in rotolo mm.6 fine mt.100
A1000SP grana 800 spuntiglio

A2315 foro tondo
A2314 foro quadro
 paraffina in conf da 1 Kg.

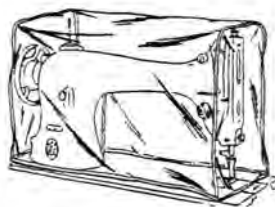

AVCASSETTI
 Cassetto in plastica con guide
 Per tavole industriali

AV12 48x25x20
AV13 63x25x20
 Copertine trasparenti .x macchine

AV101
 valigia in plastica
 per mc.domestiche

A1066 **A1067**
 gomme per pedane
 non adesive



A2500A **A2500N**
 a gas – base nailon

A2501A **A2501N**
 a gas – base metallo

A2502A
 a gas – base nailon

A2503L
 a gas – base metallo
 struttura in faggio

< struttura in polipropilene colore azzurro **A** nero **N** >

Sedie imbottite e sgabelli: vedi pag. 2

ACCESSORI



A1030/180 6x180
A1030/3x100 /3x80 /5x150

A1030 cacciavite corredo medio

A1029 cacciavite corredo piccolo



A1049 chiave brugola originale Rimoldi (Pastorino)
A1053RIM chiave brugola Rimoldi non originale
A1053 chiave brugola per Yamato – Brother
KY14 chiave brugola Siruba – Mauser –W&G

A1047
cacciavite nano
con intaglio – 4x25

A1006WB1 infila ago grande
A1006 infila ago Mery piccolo



1) **A1050** infila ago Rimoldi 990577-0-10
2) **A1050T** infila ago per tagliacuci

A1050C infilatore per crochet tagliacuci



A976 taglia asole piccolo
A976G taglia asole grande

A975
spazzolino con scovolino



A2320R foracinture multiplo
Fustelle da mm.2 a mm.5

A1045SET
set cacciaviti micro

A1135/25
portarocchetti PRYM
portarocchetti A1135 Kriko vedi pag 64

ACCESSORI



MOTORI DOMESTICI ESTERNI - 220/230V completi di staffa fissaggio, cingia e reostato

A9000 50W 1/15-5000 rpm ## **A9000/1** 60W 1/10-7000 rpm ## **A9000/3** 60W 1/12-6000 rpm
A9000/2 motorino Ocel economico **A9000J** 90W 1/8-6000 rpm (Taiwan "VGK")



MOTORI DOMESTICI INTERNI - 220/230

completi di reostato ed eventuale staffa di fissaggio

A9000/5 Necchi 50W-5000 rpm ## **A9000/503** Necchi 503 50W-5000 rpm
A9000B Borletti 40W-4000 rpm ##
A9000/V2160 Vigorelli 50W-5000 rpm (foro 35mm)
A9000/V2169-59 Vigorelli 50W-5000 rpm (foro 59mm)

MOTORI ARTIGIANALI

A9000/4 1/5-4000 rpm
A9000/4-1/3 1/3-6000 rpm



A9001J

reostato Taiwan WGK

A9002

spina americana

A9001

reostato OCEL

A9020

carter FIR

A9021 carter Moretti



A9022

freno motore

A9023

resistenza motore

A9010 frizioncina Quick Stop 532603

A9011 ferodo frizione 5/6 fori

A9012 frizione a 5 lamelle

A9013 frizione a 6 lamelle

ACCESSORI



A2230 monofase senza cavo
A2230BIS monofase con cavo

A2230TRIFASE con cavo
A2230TRIFASEBIS
senza cavo

A2230M
magnetotermico
trifase FIR

EFLEVANO
leva per motori EFKA



US21388AU Union Special



RC03-0007-0-00 Reece

A997 carboncini domestici
4x4 - 4x5 - 5x5
A998 artigianali 6x9
A998T artigianali 6x9
con treccia di rame

A1026
lampadine per mc domestiche
A1027
baionetta Ba15d - a vite E14
chiare o
smerigliate

anelli in gomma
A1043-2 **A1043-5**
A1043-3 **A1043-6**
A1043-4 **A1043-8**
A1043-10

Chiavi esagonali
per Union Special e Reece



211-356
Durkopp

05-0102-0-335
Reece mm.9,5

31237-Necchi RVG/SG/835
31539-Necchi 881/885
31240-Necchi 750/753
31019-Necchi 720/RZI

A1036
trapezoidali
a richiesta
(vedi tabella)

A1033 svil. 290/330
A1034 370
A1035 950/1020
cinghiette elastiche rosse

(la tabella sviluppi cinghie trapezoidali è a fondo catalogo in copertina insieme con la tabella di conversione pollici / mm)

ACCESSORI



A1013 Kg.5 Olio industriale per lineari	A1012 Kg.1	A1010 ml.125 c/oliatore standard / Singer	A1010S	A1012W32 Kg.1 W32 olio antimacchia	A1013W32 Kg.5	A1014 Kg.1 olio RED pesante x tagliacuci	A1015 Kg.5
--	----------------------	--	---------------	---	-------------------------	---	----------------------



A1018 /125/200/250/500 cc.
oliatori industriali becco metallo

A1019
oliatore a stantuffo

A1017 /60/125/200/250/500
oliatori industriali becco in plastica



A1089B
grasso spray
antigrippante

A1089
grasso filante
spray

A1085
spray antistatico
USA

A1014/1
olio per taglierine
verticali

AV99 tubo grande
AV99F tubo piccolo
grasso per taglierine

ACCESSORI STIRO



A9004

Tappi per valvole
(indicare misura)



A9003

microinterruttore
per ferri da stiro



A9001/1

bobina per elettrovalvola



resistenze per ferri da stiro

A9010/1 800W corazzata

A9010/2 1000W corazzata

A9010/1M 800W micanite

resistenze per ferri specifici a richiesta



A9009

elettrovalvola
completa



termostati per ferro da stiro

A9005/1 elettrovapore

A9005/2 elettrico

altri modelli a richiesta



A1141

poggiaferro in materiale
termoresistente



A9017

pistola nebulizzatrice
LECHLER



A9017/1

Pistola aria/vapore a 1 via



A9017/2

pistola aria/vapore a 2 vie



A9017/4D

pistola smacchiatrice a 2 vie
DRY

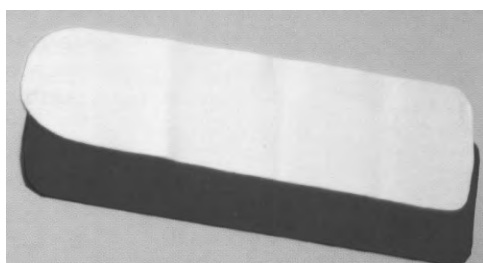

MOLLETTONE SAGOMATO COPRI ASSE

A9007M/1
A9007M/4
A9007M/8
A9007M/26
A9007M/28

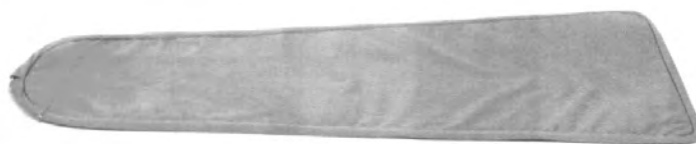

TELO TERILENE

A9007T/1
A9007T/4
A9007T/8
A9007T/26
A9007T/28

misura:

130x50x40
120x45x40
116x48x34
139x58x46
145x60x45

ACCESSORI STIRO



A9015/1J
elettrovapore
JOLLY

A9015/SG
elettrovapore
STAR grande

FERRI DA STIRO

A9015/SP
elettrovapore
STAR piccolo

A9015/3E
ferro ELETTRICO

ALTRI MODELLI SU RICHIESTA

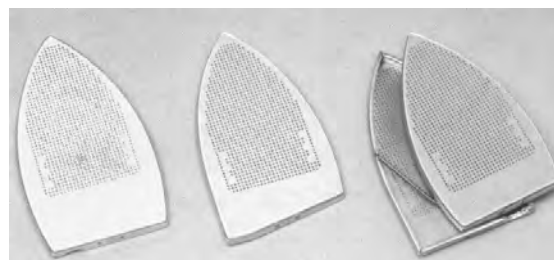
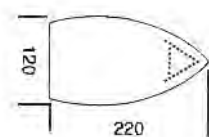

SUOLETTE IN TEFLON SEMPLICI A1140

A1140	IRONMASTER	/2
/1	VERONESI GRANDE	/3
/13	VEIT HD2000	/6
/15	VERONESI PICCOLA	/10
/16	STIROVAP 2	/22
/17	STIROVAP 3	/12
/19	TULIPANO	/18
/25	LEMM NUOVA	/20
/26	MACPI 030	/21
/32	BIEFFE PICCOLO	/23
/33	BIEFFE GRANDE	/23G
/34	GHIDINI GRANDE	/30
/35	GHIDINI PICCOLO	/31
/52	MAXI LEMM	/38
/61	BISHOMATIC	/45
		/47

SUOLETTE IN TEFLON CORAZZATE A1140C

VERONESI GRANDE
MARTIN
VERONESI PICCOLA-PONY J
BISHOMATIC-CAMPTEL
NAOMOTO CPN 410
IRONMASTER-2EFFE-CASOLI
STIROVAP 2
MACPI 030/034
STIROVAP 3
MAXSTIR PICCOLA
MAXSTIR GRANDE
SARTITALIA P-STAR-BIEFFE P
TREVIL F020
STAR G-BIEFFE G
TREVIL PROF
MAXI LEMM

Altre suolette a richiesta, specificare il modello ed in ogni caso le dimensioni del ferro come da disegno

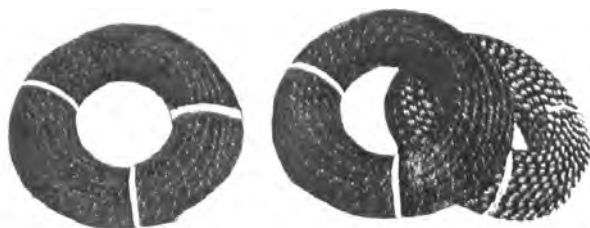

A9016 tubo vapore in gomma rivestito mt 50
A9016/1 tubo vapore silicone rivestito
A9016/2 cavo elettrico quadripolare
A9016/3 cordone per ferro elettrico

A1132
pasta per ferri EZ-OFF

A1131
stick puliferro DECAPFER
scatola da 10 pz

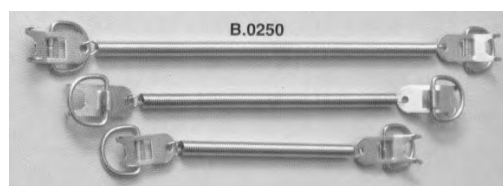

A9008 gancio a bretella
A9008/1 gancio a uncino

A9007 molla tenditelo
cm. 5 , 10 , 15 , 20 , 30 , 50

A9006 molla tenditelo con ganci
cm. 5 , 10 , 15 , 20 , 30 , 50

ACCESSORI STIRO

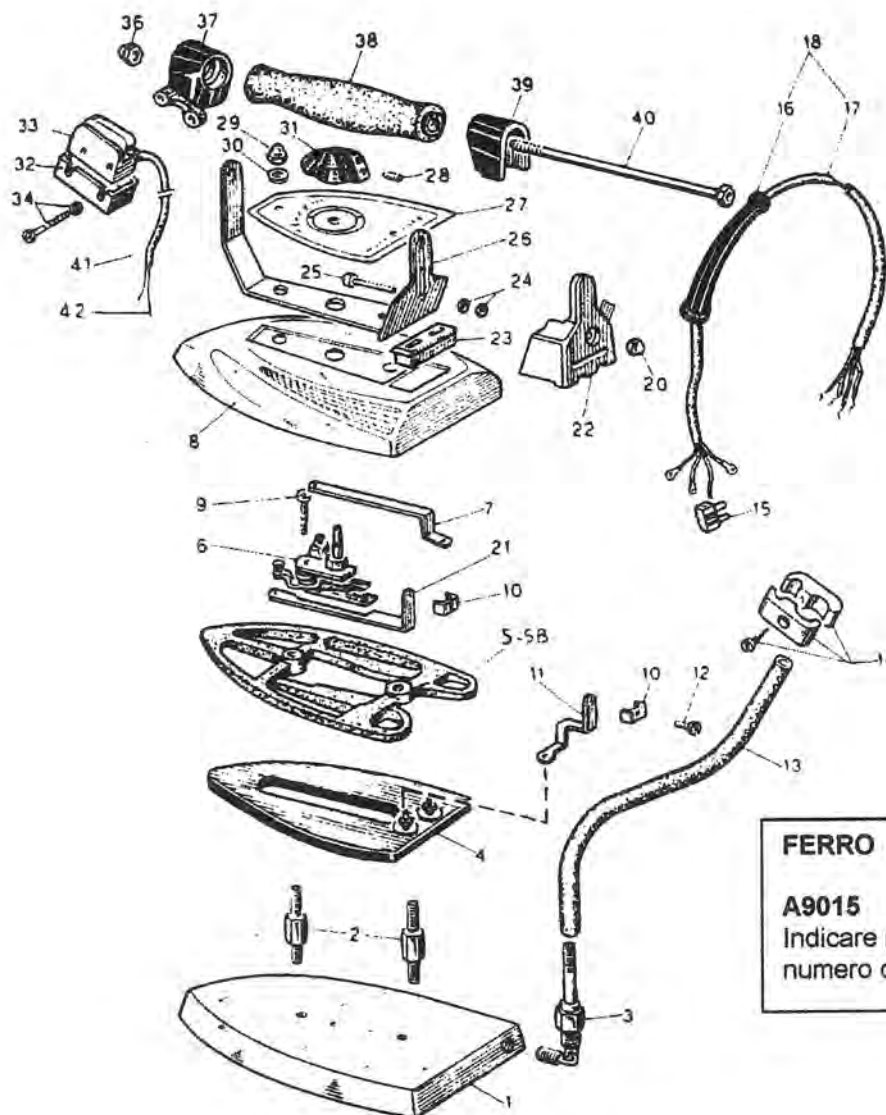

FERRO ELETTRIVAPORE

A9015

Indicare modello del ferro e numero del particolare

SONO INOLTRE FORNIBILI A RICHIESTA I SEGUENTI ACCESSORI :

- Braccetto stiramaniche
- Elettrovalvole
- Ferri da stiro
- Guarnizioni
- Mollettoni (indicare spessore)
- Nastro di teflon
- Pinze in acciaio
- Resistenze
- ricambi per ferri
- rivestimenti per piani (indicare misura piano)
- spazzola a vapore
- termostati con sonda
- tubi flessibili in acciaio
- tubo teflon per ferri
- valvole per piani

INTERPELLATECI PER OGNI VOSTRA NECESSITA'

ACCESSORI



A959
tensionatore
per nastri



A112
bottone a molla
ferma piedino

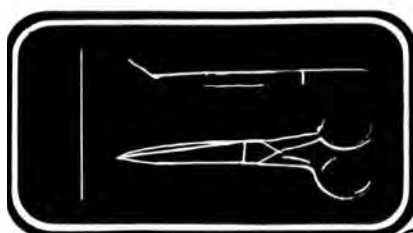

61 (90x160)
piastre magnetiche porta oggetti

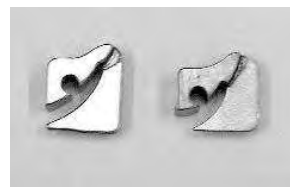

AV403 prua per piedino 3 aghi RIM
AV403M prua per 3 aghi Mauser



AK85
foot lifter for **JUKI DDL 5550**



AK118
foot lifter for **JUKI DDL 9000**

JAK85
alza piedino pneumatico / solenoide
JUKI kl 5550

JAK118
alza piedino pneumatico / solenoide
JUKI kl 9000

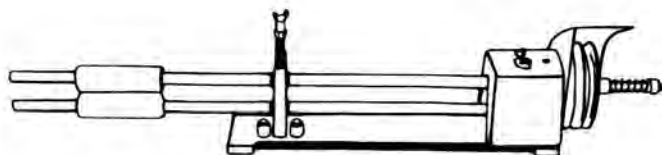

A1119
Puller tiranastri standard / universale
(Puller **RACING** completi e trasmissioni, vedi sezione relativa)

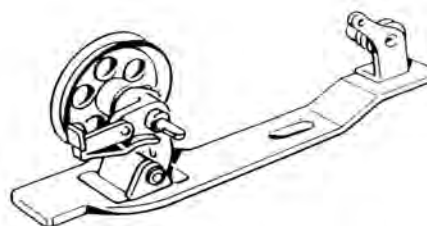

A1118
filarello da banco standard / Singer / Pfaff
filarello **JUKI** carterizzato : vedi sezione **JUKI**



GUANTI DI PROTEZIONE IN ACCIAIO 5 DITA INTERCAMBIABILI DESTRA E SINISTRA

A3012

BLU	tipo grande	(mano uomo grande)
ROSSO	tipo medio	(mano uomo normale)
BIANCO	tipo piccolo	(mano donna grande)
VERDE	extra piccolo	(mano ragazza)
MARRONE	extra-extra piccolo	(mano ragazza piccola)

FORBICI

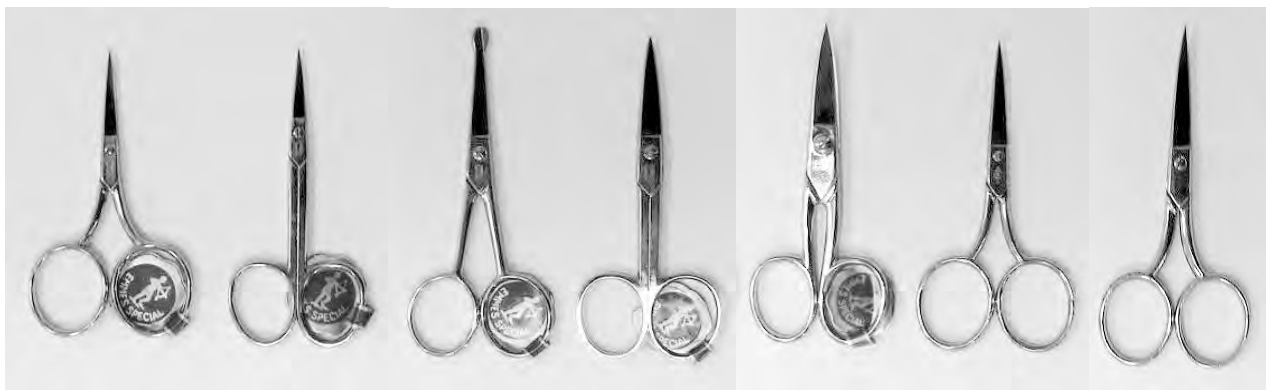

A1100 3 ½ retta **A1101** 3 ½ retta **A1700** 4" retta **A1702** 4" retta **A1701** 4" retta **A1703** 4" retta **A1704** 4 ½ retta
A1100C curva **A1101C** curva **A1700C** curva **A1702C** curva **A1701C** curva **A1703C** curva **A1704C** curva
 anelli grandi



curved handle, curved blades
manico curvo e lame curve



curved handle, curved blades
manico curvo e lame curve

A1705
manico e punta curva 4" ¼

Forbici per ricamatori sagomate
A1707 6" retta - **A1707C** 6" punta curva

A1706
manico e punta curva 4"



A1115WISS
Rasafilo WISS/USA azzurre



A1115
rasafilo plastica arancio



A1115C
rasafilo plastica punta curva



A1115MINI
rasafilo metallo azzurra



A1115/S105
rasafilo metallo dorata



A1115/S158
rasafilo plastica



A1115/TC200 plastica

A1113 metallo retta



A1115TC/100 plastica senza anello

A1114 metallo curva



FORBICI



A1102-4 4" forbice da lavoro
A1102-4,5 4 1/2"
A1102 5"
A1102-5,5 5 1/2"
A1103 6"
A1104 7"

Le versioni "PROF" marcate "professional" Sono caratterizzate da una finitura più accurata, tale da renderle particolarmente adatte all'uso professionale.

A1102PROF 5"
A1102PROF5 1/2 5 1/2"
A1103PROF 6"
A1104PROF 7"

La versione normale è comunque frutto di una accurata selezione al fine di proporre la migliore qualità al miglior prezzo.



A1105 forbice sartina 6"
A1106 forbice sartina 7"
A1107 forbice sartina 8"

A1105PROF forbice sartina 6"
A1106PROF forbice sartina 7"
A1107PROF forbice sartina 8"



A1103T4 forbice da tasca a punta tonda 4"
A1103T5 forbice da tasca a punta tonda 5"
A1103 forbice da tasca a punta tonda 6"

A1134
 cesoia per cartoni FENNEK



A1112
 forbice taglia campioni manico nero verniciato

A1112P
 forbice taglia campioni manico in plastica



cesoie acciaio brunito con manico nero verniciato
A1108 7"
A1109 8"
A1110 9"
A1111 10"
A1111/11 11"
A1111/12 12"
A1111/13 13"
A1111/14 14"

cesoie acciaio nichelato con manico nero verniciato
A1108C 7"
A1109C 8"
A1110C 9"
A1111C 10"
A1111/11C 11"
A1111/12C 12"
A1111/13C 13"
A1111/14C 14"

FORBICI



Forbici simili alla linea KAI della migliore produzione **nazionale** "professional"

A1162J mm.135
A1162JMD microdentata
A1161J mm. 165
A1161JMD microdentata
A1160J mm.210
A1160JMD microdentata

Nuova versione con rivestimento in **TITANIO**
A1162JT mm 135 **A1161JT** mm 165 **A1160JT** mm 210



Cesoie "LIGHT" **SHOZABURO**
 stesso codice delle "SLIMLIGHT" KAI ma in confezione originale Shozaburo **A1167SL9** 9" **A1167SL10** 10"



Cesoie "LIGHT" **X'SOR**
 Cesoie industriali leggere e maneggevoli di alta qualità

A1167SL8J (A220 mm 234) **A1167SL10J** (A260 mm 264)
A1167SL9J (A240 mm 250) **A1167SL11J** (A280 mm 284)
A1167SL12J (A300 mm 305)

FORBICI



A1162 KAI 5135 cm 13,5 **A1162C** punta ricurva
A1161 KAI 5165 cm 16,5 **A1161C** punta ricurva
A1161MD KAI 5165MD microdentata
A1162MD KAI 5135MD microdentata

A1164 KAI 5120 cm 12
A1164 L coppia lame ricambio
A1164J versione non originale economica



A1163 KAI 5100 cm 10
A1163C KAI 5100C cm 10 punta ricurva

A1160 KAI 5210 cm 21 **A1167** KAI 5210L sinistra per mancini
A1160MD KAI 5210MD micro dentata



A1165 KAI 5230 cm 23
 Lama ad appoggio in piano

A1169 KAI 5250 cm 25
A1169MD KAI 5250MD microdentata

A1157 KAI 5275 cm 27,5



A1166 KAI 5350 cm 20
 Cesoia taglia campioni

A1164/N5125
 Forbice rasafilo

FORBICI



A1161C
KAI 5165C p. curva
cm. 16,5

A1162C
KAI 5135C p. curva
cm. 13,5



A1160N
forbici KAI ergonomiche per ricamatrici
cm. 18

A1161N
cm. 16

A1162N
cm. 14



A1176S/10
KAI 7250 10"

CESOIE KAI SERIE 7000

A1176S/11
KAI 7280 11"

A1176S/12
KAI 7300 12"



A1167SL9 SLIMLIGHT 9"

CESOIE KAI SERIE "SLIMLIGHT"

A1167SL10 SLIMLIGHT 10"

FORBICI



A1165J 8"1/2 **A1165J9** 9" **A1168J** 9"1/2 **A1169J** 10"
Cesoie manico in plastica nero Nazionali economiche



A1190/8 **A1190/9** **A1190/10** **A1190/11** **A1190/12**
Cesoie **KAI** serie **SB** acciaio e manico nero verniciato

FENNEK

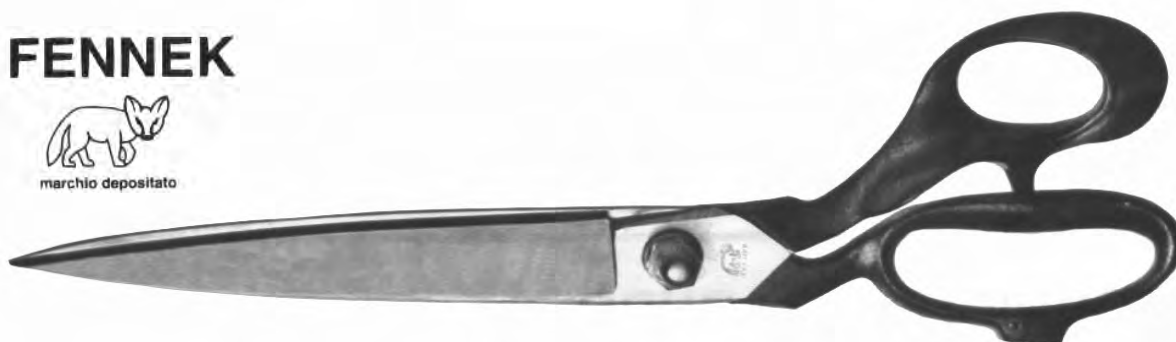

Cesoie per tagliatori **FENNEK** Acciaio nichelato e manico nero verniciato
A1111/12F **A1111/13F**

FENNEK

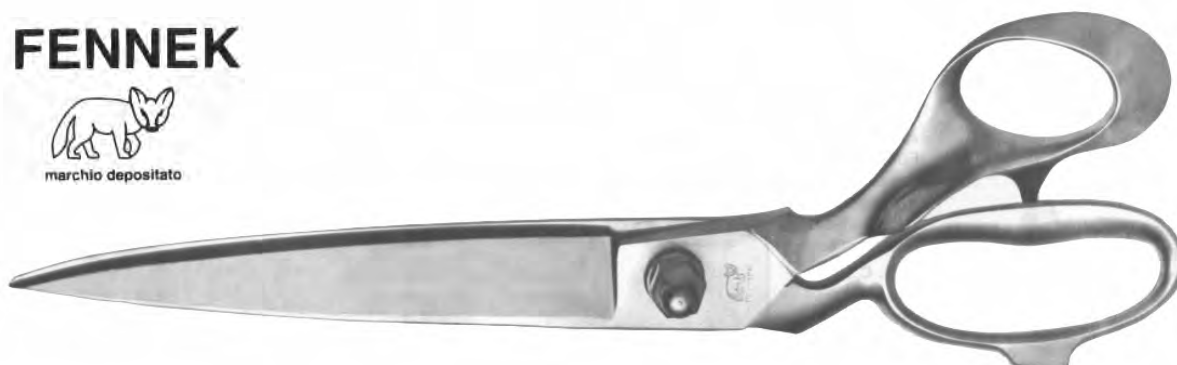

Cesoie per tagliatori **FENNEK** tutta in acciaio nichelato
A1111/12FN **A1111/13FN**

FORBICI



A1102FS FENNEK lavoro sinistra 5"
A1103FS FENNEK lavoro sinistra 6"
A1104FS FENNEK lavoro sinistra 7"



A1105FS FENNEK sartina sinistra 6"
A1106FS FENNEK sartina sinistra 7"
A1107FS FENNEK sartina sinistra 8"



A1109FR
 Cesoia per rifilo FENNEK 8"

FENNEK



A1109FS
 Cesoia sinistra per mancini 8"
A1111FS 10"
A1111/12FS 12"

FENNEK



A1109FRS
 Cesoia per rifilo FENNEK sinistra 8"

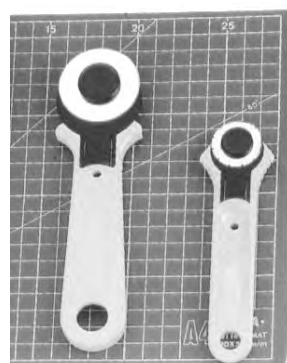
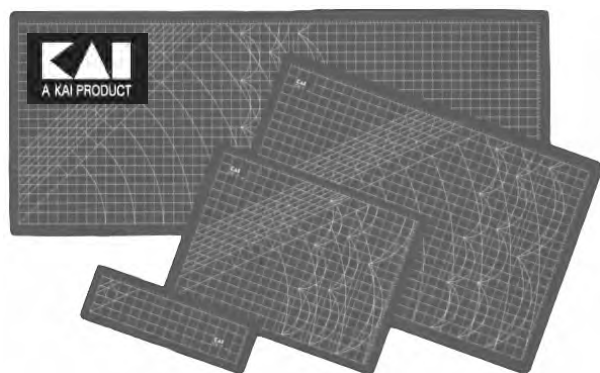

A1178 rollcutter KAI 5045 diam.mm 45
A1178L lama ricambio mm 45
A1178LON lama ricambio ondulata mm 45
A1175 rollcutter KAI 5028 diam.mm 28
A1175L lama ricambio mm 28
A1177 tappetino KAI per rollcutter cm 60x45
A1177/1 tappetino KAI per rollcutter cm 60x90
A1177/2 tappetino KAI per rollcutter cm 60x143

rollcutter simili alla versione Olfa
A1178J diam mm 45
A1178JL lama ricambio mm 45
A1175J diam mm 28
A1175JL lama ricambio mm 28
A1177J tappetino cm 60x45
A1177/1J tappetino cm 60x90

ACCESSORI



A4000TN1 FORBICE PER TAGLIO A CALDO

Impiegata per taglio manuale e termosaldatura contemporanei di materiali sintetici con spessore massimo di 2 mm. in caso di polipropilene, mentre per il poliestere lo spessore passa a un max di 0,5 mm.
Alimentata a 220v. con trasformatore a 24 v di sicurezza temperatura da 0 a 200°



A2000-H2
bobbinatore a 2 coni

A2000-H4
bobbinatore a 4 coni
(apparecchi a norma CE monofase 220V)



A2000-H1
avvolgitore per spoline



A5000KDH - 150
trapano a caldo - altezza utile mm 150
temperatura massima 500°
monofase 220V

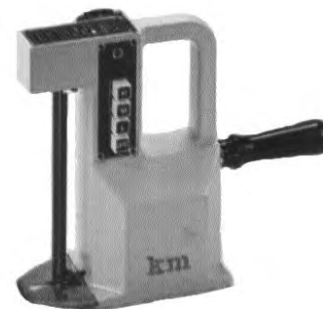

A5000KH - 200
segnataghe a caldo - altezza utile mm 200
temperature da 300 a 500°
monofase 220V

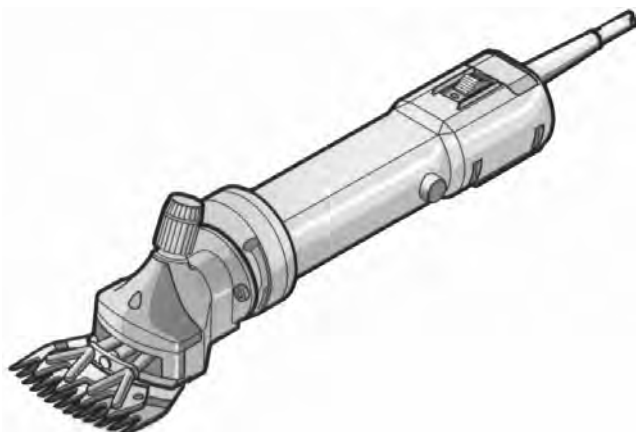

A4000-H701-901

Rasatrice elettrica **HEINIGER**
Potente e affidabile, 220v - 380W

A4000H701901L
Coppia lame di ricambio

ACCESSORI



A1099
Adesivo temporaneo
per ricamo
e sala taglio

A1099FORTE
adesivo temporaneo
forte
potenziato per tessuti porosi

A1099TAK
adesivo temporaneo
(TAKTER 800)
il più perfezionato

A1097
aria compressa

A1096
detergente per mole
e taglierine



A1093
Detergente per adesivi
Incrostazioni ricamo,
non rovina plastica e vernici

A1089
grasso filante spray

A1011SPRAY
olio lubrificante spray

A1095
olio sbloccante universale

A1088
grasso spray
al Teflon



A1082PNS
Pulitore per nastri gomma
Termoadesivi-Fusing machine
A1082PNL
Versione liquida in fusti da 5 lt
A1082PNP in polvere

A1085TK
spray antistatico
TAKTER 310

A1089/1
impermeabilizzante
per tessuti

A1025
silicone spray extra
ml. 500 netto

A1089B
grasso spray
antigrippante



Production since 1957



ACCESSORI



A1098
Adesivo permanente

A1098FORTE
adesivo permanente
Forte

A1021
silicone emulsione bianco
A1021/5 tanica da 5 kg

A1023
silicone puro trasparente
a bassa densità
A1023/5 kg.5

A1020
silicone puro trasparente
ad alta densità
A1020/5 tanica da kg.5



A982
Vaschetta per silicone con serbatoio

A981
vaschetta per silicone senza serbatoio
in metallo

A982DL1
vaschetta universale con staffetta,
applicabile su tutte le macchine piane

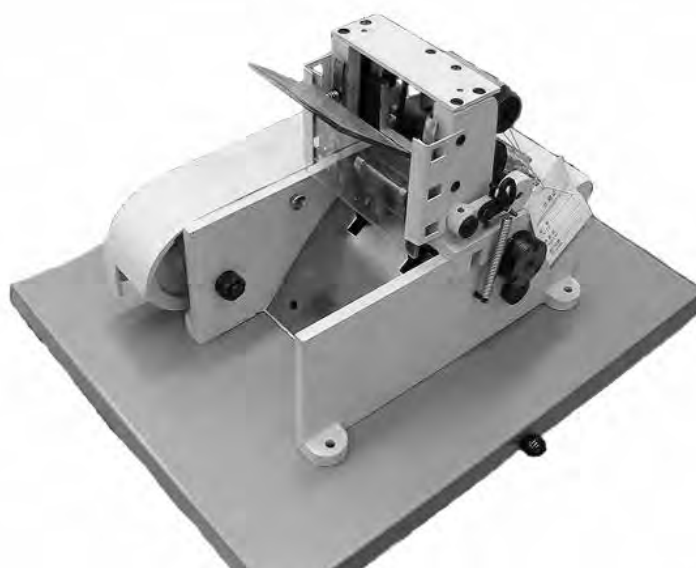

KBK12
Dispositivo taglia passanti tipo Kansai
Completo di tavolo e motore a giri fissi

ACCESSORI



A2004

AFFILATRICE MONOFASE 220V
PER COLTELLI TAGLIACUCI INDUSTRIALE

A2004FM

AFFILA FORBICI CON MOLA PIANA ADDIZIONALE
A2004FS affila forbici con spazzola fine

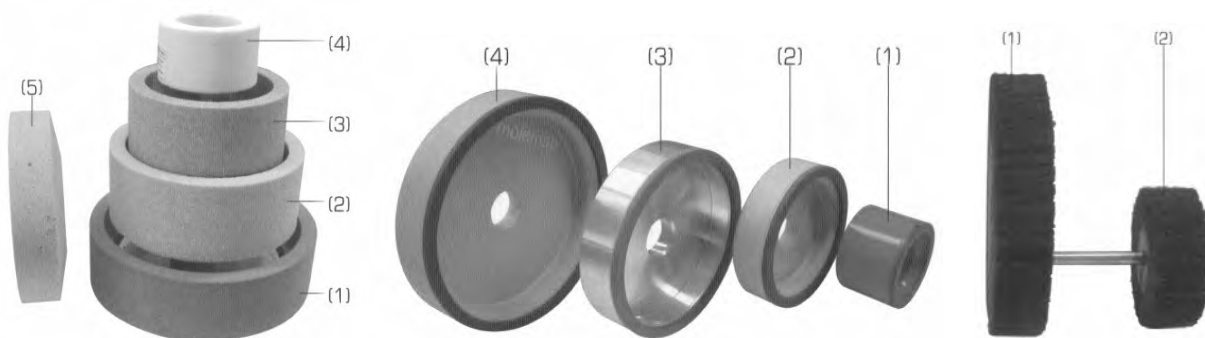

A2083 mola tazza 100x40x12 (2)
A2083/80 80x40x12 (3)
A2085 125x16x20
A2085/1 125x35x12 (1)
A2070SM 50x30x12 (4)
A2083/2 per affilatorbici (5)

A2084 mola a tazza diamantata mm 100x40
A2084/1 mola a tazza diamantata mm 80x22
A2084/2 mola a tazza diamantata mm 125x38
A2071SM mola a tazza diamantata mm 50x30

A2087/1 spazzola fine mm 100x20
A2073/1 spazzola fine mm 60x20

A2085 mola piana 125x16x20

MORSETTI IN ALLUMINIO PER AFFILATRICE (altre versioni fornibili a richiesta)

Rimoldi:

A2029 x 204435
A2030 350107
A2031 350182
A2032 350452
A2040 kl.27
A2041 kl.29
A2042 302808
A2063 302807
A2064 306223/224
A2059 Stella stretti
A2061 Stella larghi
A2054 306234
A2055 306235

Brother

A2057/956 x 148815-112436
A2057 x 140242
A2058 x 112436
US99BL blindstitch
A2065 x 209L/209R
A2043 x 208L/208R
Union Special
A2044 kl.39500
A2045 kl.51400
Yamato
A2051 x 30421
A2052 x 20491
A2037 x 2100167
A2035 x 22195/20491
A2052/3 kl.8020

Siruba

A2048 x KR35*
A2049 x KR23*
W&G/Mauser
A2048 kl.9000*
A2049 kl.9000*
A2050 x 204161
A2036 x 210755
A2047/1 x 211662
A2047/2 x 277009
A2050/1 x 202570
Speciali:
per asole a richiesta
Pfaff-Reece-Necchi ecc.
A2060 universale regolabile
A2062 speciali su campione

Juki

A2039 x 11845609
A2038 x 11846003
A2033 x 11845807
A2038/1 x 11845906
A2039/2 x 11845708
A2020 x 305248
A2020/1 x 305240

Vari

A2056 kl.471 Pfaff
A2046 kl.246/990 Singer
A2047 Merrow
A2053 Adler 367



A2082

Pasta abrasiva per mole gr. 500

Morsetti in alluminio per affilatrice
Vedere la tabella sopra, a richiesta sono
fornibili morsetti su coltello campione

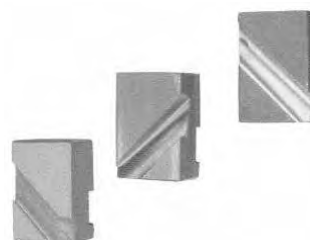

ACCESSORI



B147919-002

Gomme e cerniere per **BROTHER**
B147919-001

B143910

B143882



gomme , cerniere e ginocchiera
DURKOPP



DK223-459K

DK222-473NO

DK70055

DK70054



gomme, cerniere e ginocchiera
NECCHI



N121490

N568230NO

N533130

N533152



gomme, cerniere e ginocchiera
PFAFF



P171412

P032804

P032805

P029450

ACCESSORI

SPAZIATORI PER BOTTONI: LEWIS - SINGER - REECE



A3450
BS 200
BUTTON SEWER SPACING GAUGE,
FOR LEWIS 200CL. TYPE



A3451
BS 200M
BUTTON SEWER SPACING GAUGE,
ON MENS WEAR, FOR LEWIS 200CL.

A3452
BS 200L
BUTTON SEWER SPACING GAUGE,
ON LADIE'S WEAR, FOR LEWIS 200CL.

BUTTON HOLE SPACING GAUGES



A3453
G71V
BUTTON HOLE SPACING GAUGE,
HORIZONTAL ON LADIE'S BLOUSE
FOR 71 CLASS



A3454
G71H
BUTTON HOLE SPACING GAUGE,
VERTICAL ON MENS SHIRTS
FOR 71 CLASS

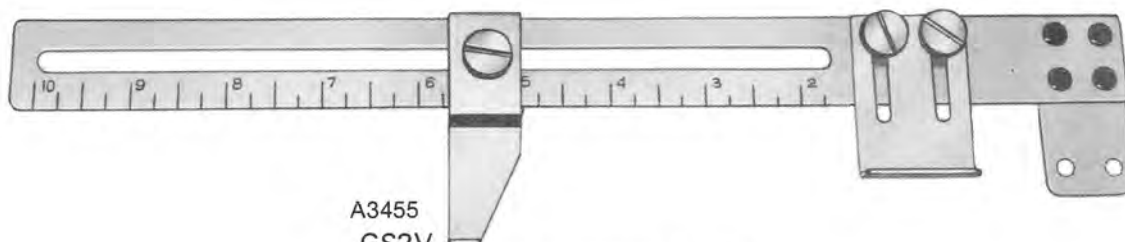

A3455
GS2V
BUTTON HOLE SPACING GAUGE
VERTICAL FOR REECE S-2CL.

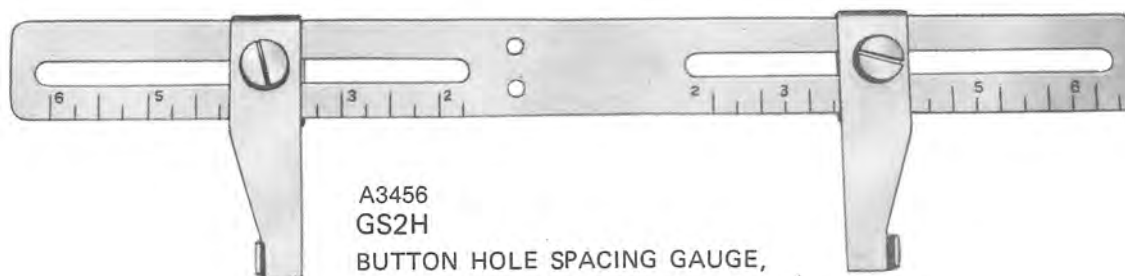

A3456
GS2H
BUTTON HOLE SPACING GAUGE,
HORIZONTAL FOR REECE S-2CL.

ACCESSORI

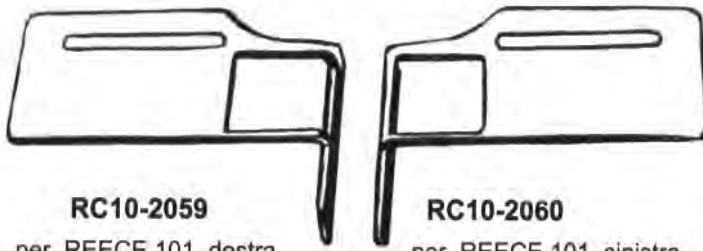

RC10-2059
per REECE 101 destra

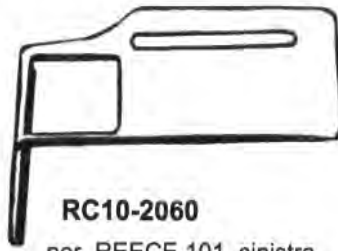

RC10-2060
per REECE 101 sinistra



B8210-372-0A0
portabottoni JUKI / LEWIS

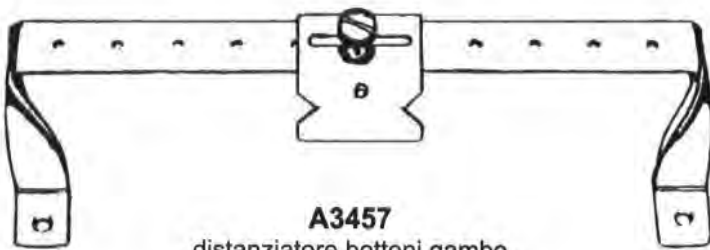

A3457
distanziatore bottoni gambo
per Singer 175 e Lewis
versione da bancale - bilaterale

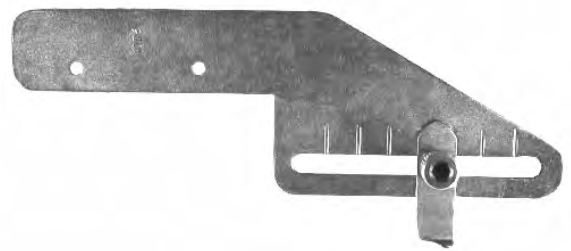

P046646NO
Spaziatore per asole Pfaff
KL. 3114 - 3116

APPARECCHI PIEGHETTATORI

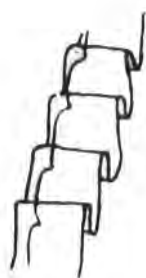
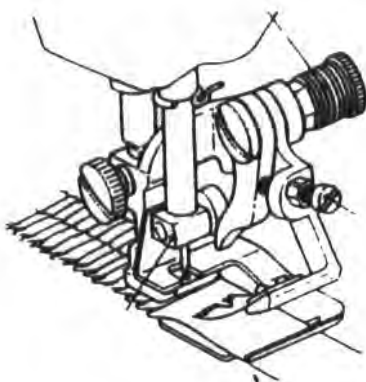

A960
pieghettatore regolare
una piega - un punto

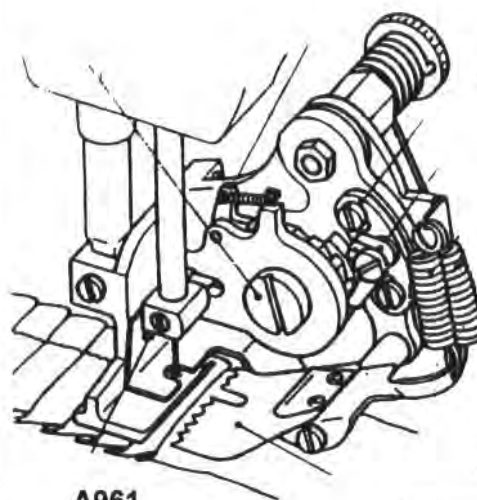

A961
tipo speciale con camme
produce una piega regolare
ogni punto, oppure
una piega ogni 4 o 8 punti

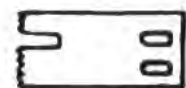
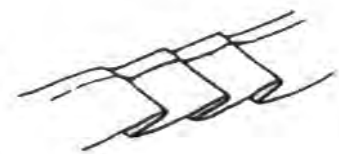

lamella ricambio e morsetti
con foro di vari diametri
a richiesta



camme per 4 e 8 punti
comprese nel kit

LAMPADE



A974M faretto a Led magnetico e posizionabile ovunque, **trasformatore incorporato**. studiato per evitare al massimo le vibrazioni dovute alla macchina

A974MT stesse caratteristiche del modello **A974M** ma con **trasformatore separato**

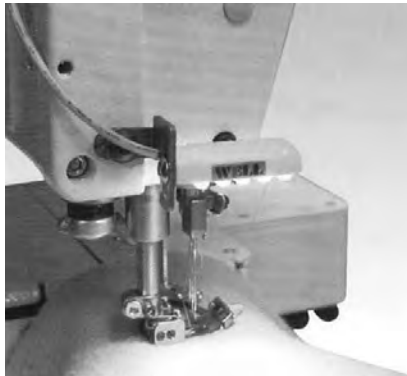

A974P - T

A974P con staffe di fissaggio per macchine piane
A974T con staffa di fissaggio per tagliacuci



A973/100LF3
 Lampada con lente biconvessa in vetro ottico
 Lampada fluorescente da 22W protetta da schermo frangiluce
 a norma CE – completa di cavo e spina
A973/70-93
 Carrello opzionale

LAMPADE



LAMPADE AL NEON Conformi alle normative CE

Facile installazione-snodi anti vibrazioni-robusto e affidabile.
la versione con staffa è fornita di vite fissaggio per Juki – Brother e altre con lo stesso filetto.
Per macchine europee va utilizzata una vite con filetto adatto oppure rifilettare il foro.

A973JCPL snodata con morsetto da banco
A973J2 snodata con staffa fissaggio testa.

Fluorescent
PL Lamp (7W)



E149992

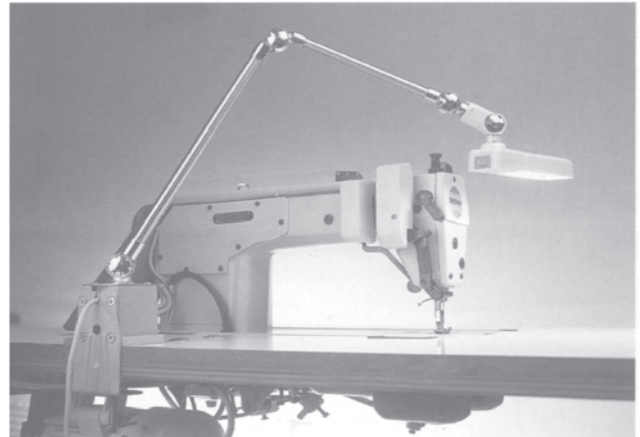
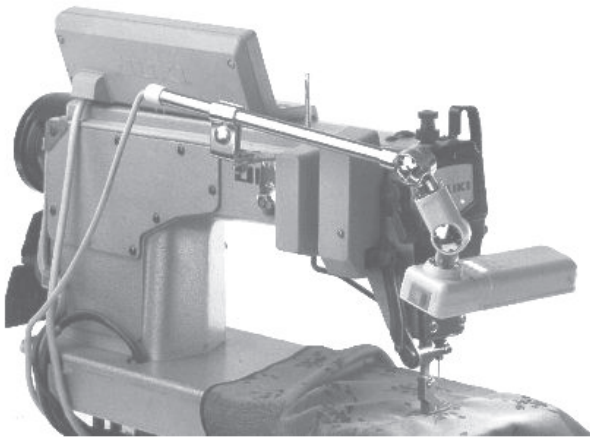

A973JCPL

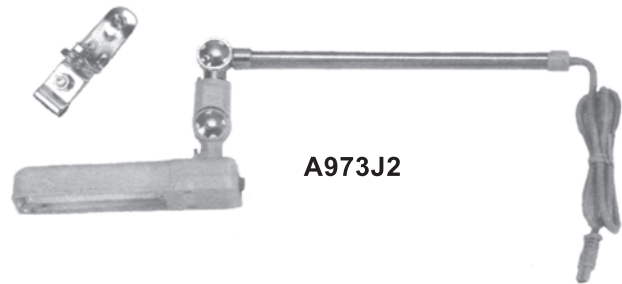

A973J2



A973J27TRASF
reattore per A973J2

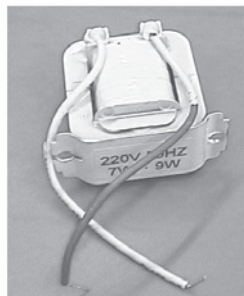

A973J98TRASF
reattore per A973JCPL

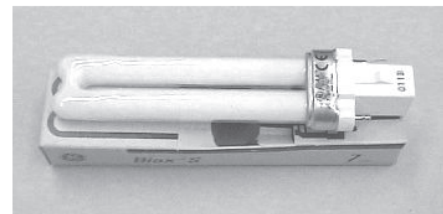

A973JLAMP
lampada neon Dulux 7W

LAMPADE

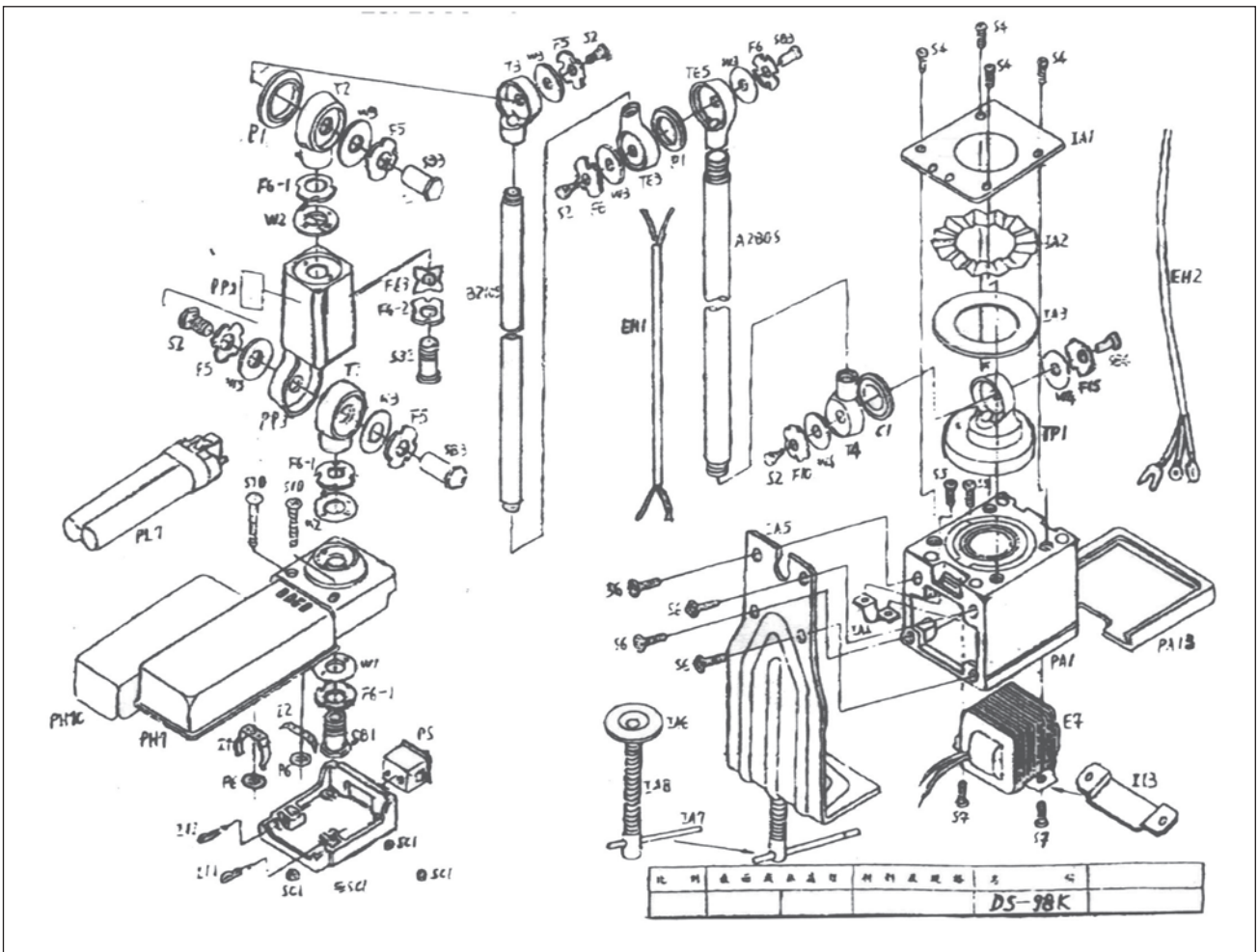

ricambi per A973JCPL e A973J2

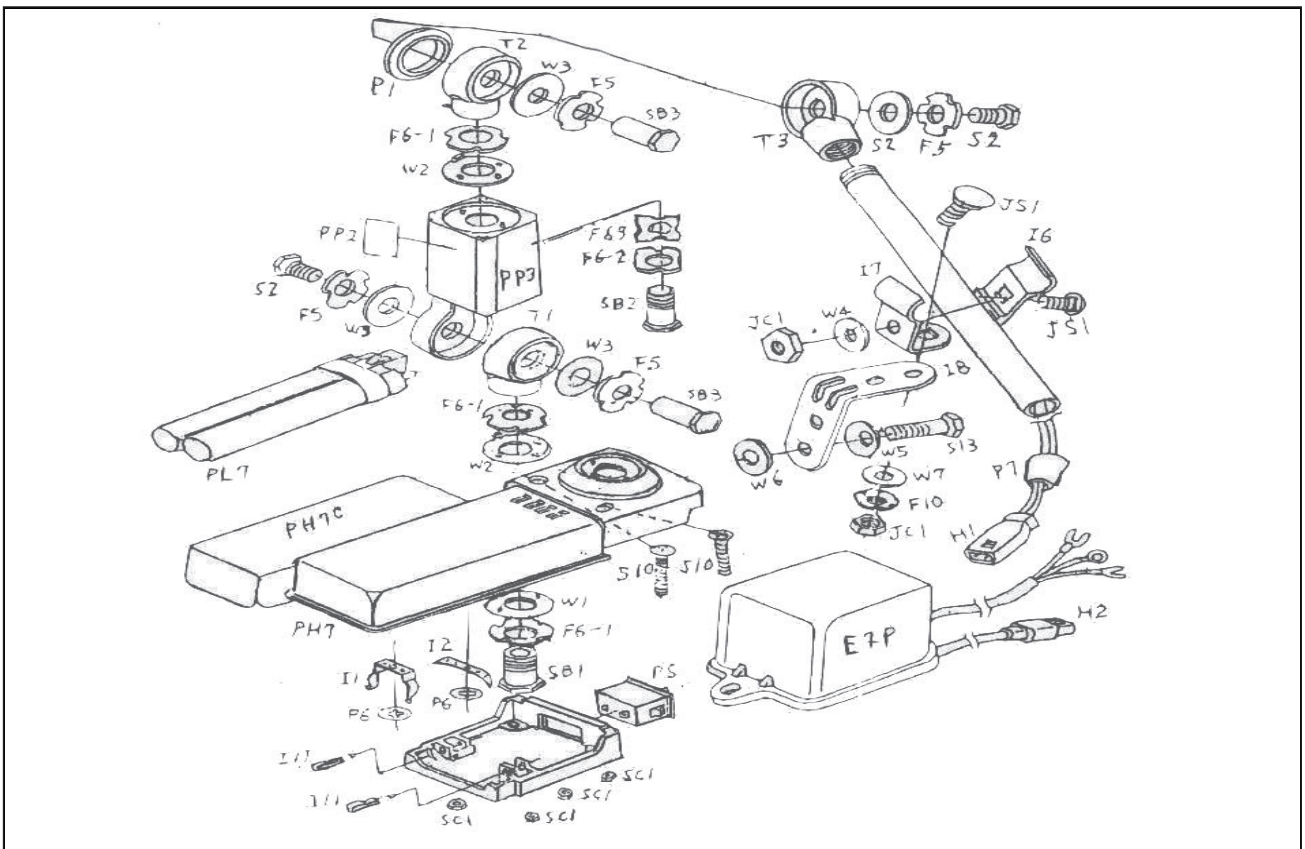

LAMPADE



A7LED
trasformatore
per tutti i modelli
LED

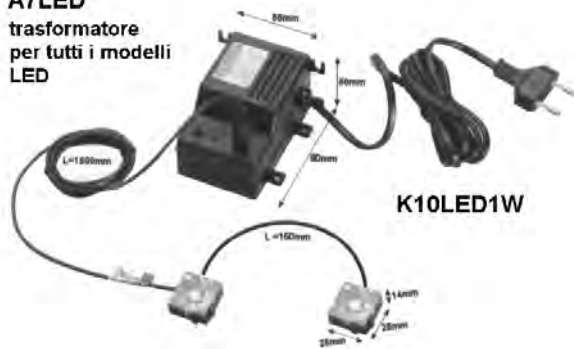

K9LED1W- kit illuminante a Led modulare magnetico

Lampada LED **completa di alimentatore** stabilizzato . 1W 230V

particolarmente adatto per essere impiegato come sorgente di luce in una macchina per cucire per illuminare il punto di lavoro.

A7LED alimentatore separato 1 via
Per tutti i modelli LED

A13350VL alimentatore fino a 3 vie

K10LED1W- kit illuminante a 2 LED modulari magnetici da 1W **completo di alimentatore** stabilizzato . 1W x2 230v

C.C.E.A.
ILLUMINAZIONE TECNICA

K7LED1W – Kit illuminante LED a luce fredda **completo di alimentatore** stabilizzato

Particolarmente adatto per essere impiegato come sorgente luminosa per macchine da cucire, punzonatrici, rivettatrici e in tutte le macchine dove necessiti una luce concentrata nella zona d'azione dell'utensile. Particolarmente resistente agli urti e alle vibrazioni data l'assenza del filamento

P11
Lampada magnetica ad incandescenza
10W/ 12v 230v (solo faretto)

0011 **kit completo** di trasformatore 12v/230v e potenziometro.

R10 potenziometro separato
T5 trasformatore separato 10W
2/A lampadina ricambio a siluro

ricambi per modelli fuori produzione **P9 – P7**

art 1 lampadina a goccia per P7 e P9
T5 trasformatore per P7
T5B trasformatore per P9
R10 potenziometro per P7 e P9

LAMPADE



ALASER2230



PUNTATORE LED

Sistema di puntamento e/o posizionamento a LED. Impiega un LED di potenza ad alta efficienza.

28CR1 L1V modello base 1W croce standard verde
28PT1 L3R modello 3W punto standard rosso
28OL1-B ologramma standard bianco

il trasformatore viene fornito separatamente:

A7LED alimentatore LED 1W
A11LED alimentatore LED 3W



SISTEMA DI PUNTAMENTO AL LASER

I puntatori laser sono stati progettati e costruiti per l'allineamento e il posizionamento di materiali in diverse applicazioni. Pertanto, possono essere installati su macchine da cucire come pure su macchine da taglio, presse, macchine per maglierie, da stiro, da ricamo, banchi dal lavoro, officine meccaniche industriali.

il laser emette luce rossa
 il trasformatore viene fornito separatamente

LASER650PD punto debole-campo da 5 a 100 cm
LASER650PF punto forte-campo da 50 a 500 cm
LASER650LD linea debole-campo da 10 a 65 cm
LASER650LF linea forte-campo da 50 a 250 cm
LASER650CD croce debole-campo da 6 a 50 cm
LASER650CF croce forte-campo da 50 a 200 cm

ALASER2230 alimentatore per puntatori LASER
 230v 1,2W

21 art 1 posizionatore a croce ad incandescenza 5W 12v
 lampadina a goccia ricambio

T5B trasformatore 230v 5W 12v
 Il trasformatore è fornito separatamente

16 attacco per posizionatori a braccetto rigido

34 attacco per posizionatori con snodo regolabile

LAMPADE



P14 5w 12v
alogeno bispina completa di braccetto
lampadina per P14 art **4/a**



P14F 5W 12v
alogeno bispina – stelo cm 18 flessibile
con snodo.
lampadina per P14F art **4/a**



P15H 5W 12v
a incandescenza
stelo 18 cm flessibile con snodo
lampadina per P15H art **1**



P990/50-70
lampada alogena a stelo lungo flessibile
luce diffusa – 20W 12v
stelo da 50 o 70 cm fissaggio con viti o
con morsetto opzionale **CLAMP03**
lampadina art **4/C**

LAMPADE



P220/50-70

lampada alogena dicroica a stelo lungo flessibile
luce concentrata – 20W 12v - cm 50 o 70
fissaggio con viti o morsetto opzionale **CLAMP03**
lampadina art **4/H**



P330/50-70

lampada alogena dicroica a stelo lungo flessibile
luce concentrata – 10W 12v - cm 50 o 70
fissaggio con viti o morsetto opzionale **CLAMP03**
lampadina art **7**



P770/50-70

lampada neon stelo lungo flessibile cm 50 o 70
luce diffusa bianca – neon 9W 230v
fissaggio con viti o morsetto opzionale **CLAMP03**
lampadina art **5/B**



P880/50-70

lampada alogena a stelo lungo flessibile
luce concentrata – 10W 12v cm 50 o 70
fissaggio con viti o morsetto opzionale **CLAMP03**
lampadina art **4/B**

LAMPADE

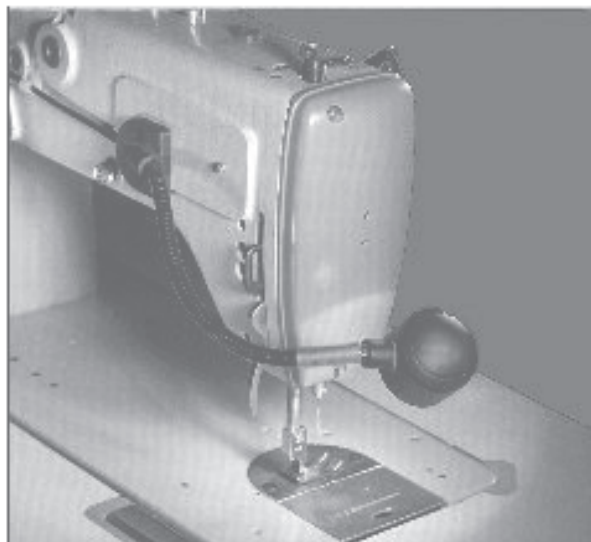

A1180 faretto alogeno 5W 12V
stelo da 13 cm.

A1180/580 faretto alogeno 5W 12V
stelo da 58 cm.

T5B trasformatore 220-12V 5W

A1180L lampadina alogena ricambio

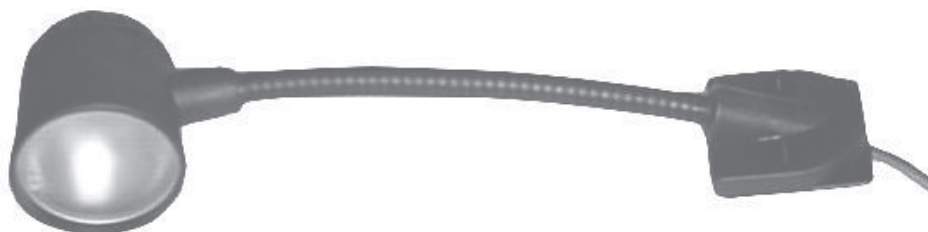

SEZIONE : CROCHET – CAPSULE – SPOLINE

tabella varianti punte crochet

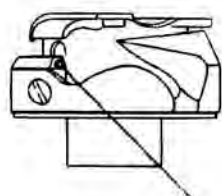

senza punta (tipo A)
per pesante

con punta (tipo B)
per leggero e pesante

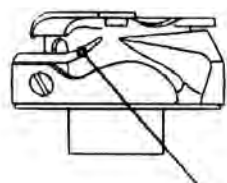
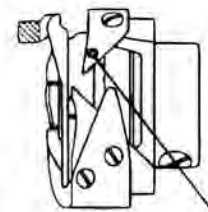

con punta (tipo B)
per leggero e pesante

troncato (tipo C)
per leggero e medio

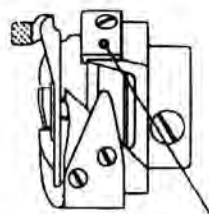
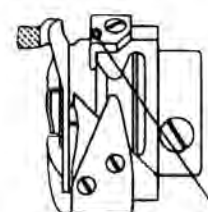

senza punta (tipo A)
per pesante

versione con molla
antiblocco "JP", se
il filo si blocca, è
possibile sbloccare il
crochet senza smontarlo

