

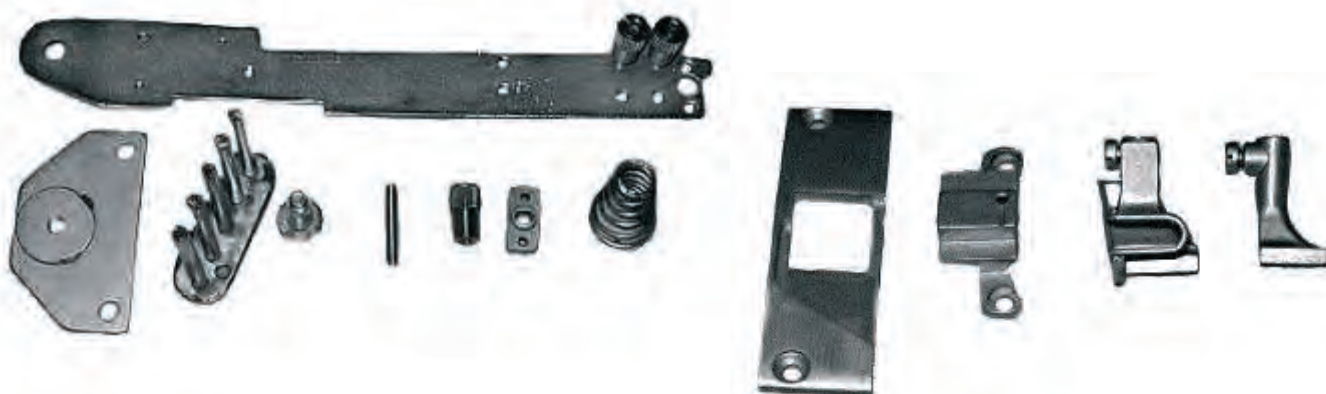

## TRASFORMAZIONI PELLE



### ADLER KI. 467-767LG SINISTRA (BROTHER B891)

|            |                              |               |                              |
|------------|------------------------------|---------------|------------------------------|
| 367-240423 | piastra per bordare completa | APS367-240423 | attacco trasporto piastra sx |
| 367-220103 | pieдино esterno              | 367-200290    | placca per bordare sinistra  |
| 067-220993 | pieдино interno              | 367-210200    | griffa per bordare sinistra  |

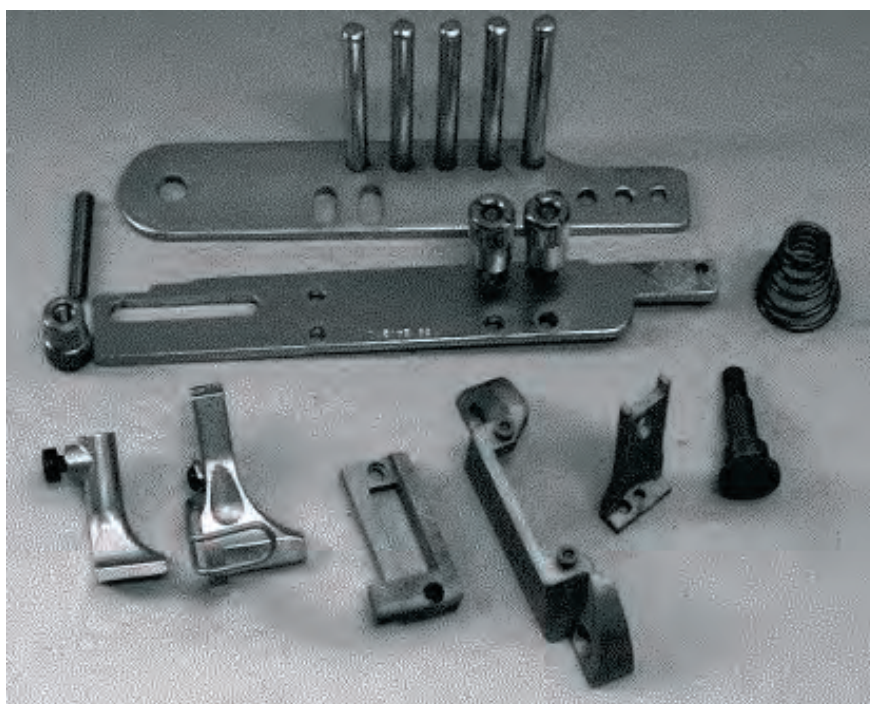

### ADLER KI.169-269

|            |                   |            |                    |            |                      |
|------------|-------------------|------------|--------------------|------------|----------------------|
| 169-220030 | pieдино esterno   | 169-200030 | placchetta         | 169-200040 | porta placca         |
| 067-220993 | pieдино interno   | 169-210040 | griffa             | 169-240210 | piastra vib.completa |
| 169-240213 | piastra anteriore | 169-240183 | piastra posteriore |            |                      |

## TRASFORMAZIONI PELLE



### PFAFF KI.145-545-1245

045607 piastra vibrante completa 145/545  
 044227 piedino esterno  
 042819 piedino interno  
 045592 placca per bordare 145/545  
 045591 griffa per bordare 145/545



### PFAFF KI. 1425

045607 piastra vibrante completa  
 049862 piedino esterno  
 049491 piedino interno  
 150601 placca per bordare 1425  
 059934 griffa per bordare 1425



### PFAFF KI.335

040432 piedino esterno per bordare  
 040431 piedino interno per bordare  
 046498 placca per bordare  
 046497 griffa per bordare  
 040895 piastra vibrante completa

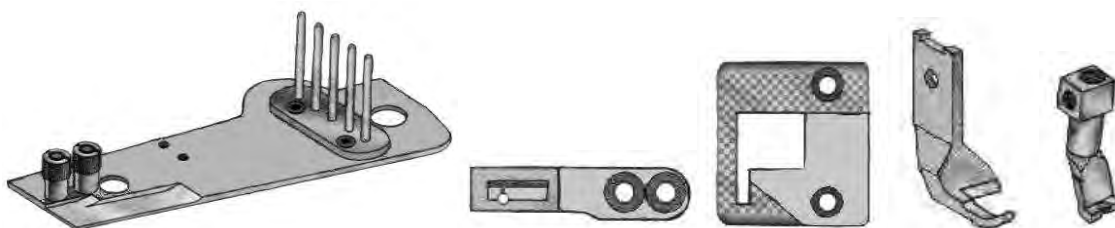

### NECCHI KI.840

|         |                    |                           |                    |
|---------|--------------------|---------------------------|--------------------|
|         | N109196            | piastra vibrante completa |                    |
| N109111 | placca per bordare | N916106                   | griffa per bordare |
| N90315  | piedino esterno    | N916107                   | piedino interno    |

## TRASFORMAZIONI PELLE

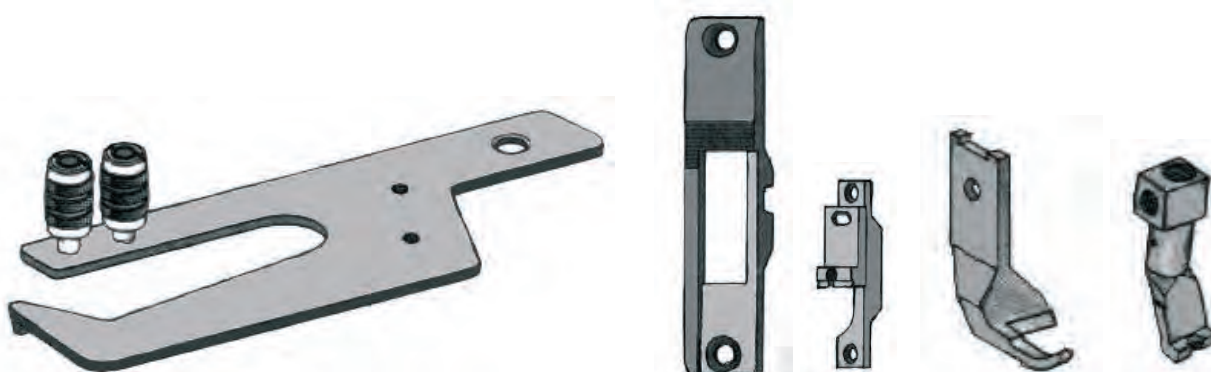

### NECCHI KI.902

|         |                    |                           |         |                    |
|---------|--------------------|---------------------------|---------|--------------------|
| N380028 | N380027            | piastra vibrante completa | N380029 | griffa per bordare |
| N90315  | placca per bordare | pievano esterno           | N916107 | pievano interno    |

## STAFFE PORTA BORDATORI

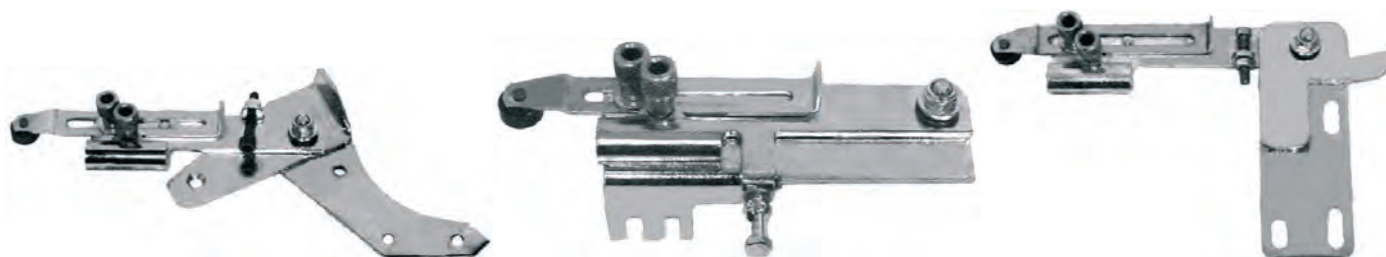

ADLER KI.67-167-267  
PFAFF KI.145-245-1245  
NECCHI KI 900-902

ADLER KI.69

ADLER KI.467

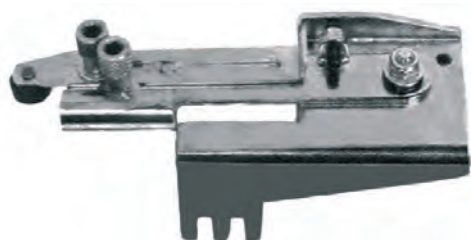

ADLER KI 169

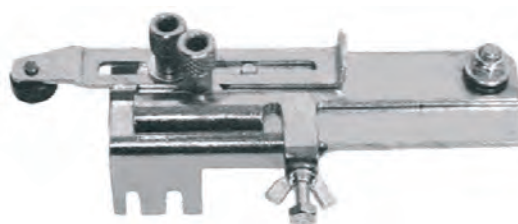

NECCHI KI 840 PFAFF KI 335

## BECCUCCI-BORDATORI-TRACOLLE

Beccucci, bordatori e tracolle sono fornibili su richiesta; Specificare: larghezza fettuccia e suo spessore, spessore del materiale da bordare e tipo di piega richiesta. In ogni caso è preferibile disporre del campione di materiale

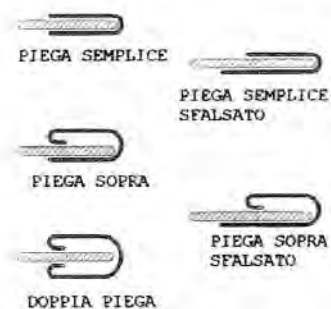

**A3460** Specificare il tipo di macchina, la larghezza della fettuccia, lo spessore della fettuccia e lo spessore del materiale da bordare



**A3461** Specificare il tipo di macchina, la larghezza della fettuccia, lo spessore della fettuccia e lo spessore del materiale da bordare

## GUIDE RIBALTABILI



**A1129/NS124** ribaltabile normale    **A1129/NS126** ribaltabile registrabile    **A1129J** ribaltabile micrometrica lunga  
Si applicano a tutte le macchine : ADLER-PFAFF-NECCHI ecc.

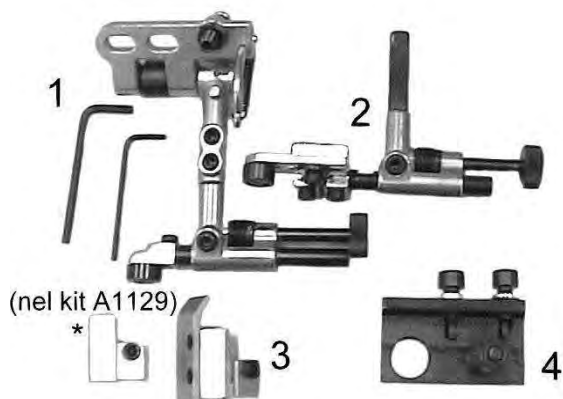

1 – guida lunga **A1129J**  
2 – portabordatore **A1129J2**  
3 – guida diritta **A1129B1**  
4 – staffa adler **A1129JS467/767**  
**A1129JS/4180** per Adler 4180



**A1129JS/1425**  
staffa per adattare la guida A1129J su PF1425

## TRASFORMAZIONI E PIEDINI PER PELLETTERIA



### ADLER KL.69

|           |                     |
|-----------|---------------------|
| 069-22121 | pedino interno      |
| 069-00394 | pedino esterno      |
| 069.00133 | placca pelletteria  |
| 069-00268 | griffa foro normale |
| 069-21018 | griffa foro grande  |
| 069-00153 | piastra braccio     |



### ADLER KL.767

|            |                |             |              |            |                |            |                |
|------------|----------------|-------------|--------------|------------|----------------|------------|----------------|
| 367-220983 | pedino esterno | N367-200030 | placca 6 mm. | 367-220993 | pedino esterno | 167-220183 | pedino interno |
| 067-220633 | pedino interno | N467-210040 | griffa 6 mm. | 467-200090 | placca 8 mm.   | 467-210070 | griffa 8 mm.   |



#### Guide battuta da applicare alle guide A1129



|                                 |                |
|---------------------------------|----------------|
| 1°                              | A1129/ 6765/10 |
| Guida dritta normale.           |                |
| 2°                              | A1129/ 6765/12 |
| Guida dritta pesante destra.    |                |
| 3°                              | A1129/ 6765/13 |
| Guida dritta per zig-zag lento. |                |
| 4°                              | A1129/ 6765/15 |
| Guida dritta pesante sinistra.  |                |

### PIEDINI ADLER KL.467/767

|                               |                    |   |         |
|-------------------------------|--------------------|---|---------|
| mezzi piedini destri da 6 mm. |                    | mezzi piedini sinistri da 6 mm.           |         |
| D6                            | esterno 067-220713 | interno                                   | E6      |
| mezzi piedini destri da 8 mm. |                    | mezzi piedini sinistri da 8 mm.           |         |
| D8(367-220283)                | esterno            | 167-220323                                | interno |
|                               |                    | E8(367-220343) esterno 167-220303 interno |         |

## PLACCHE E GRIFFE ADLER

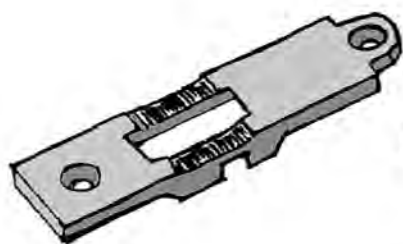

067-20-036-0  
067-20-036-0  
Throat Plate (67; 68 Class)

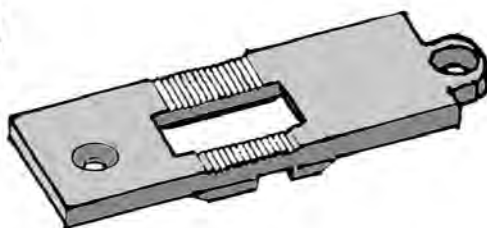

167-20-007-0  
Throat Plate (167 Cl.)

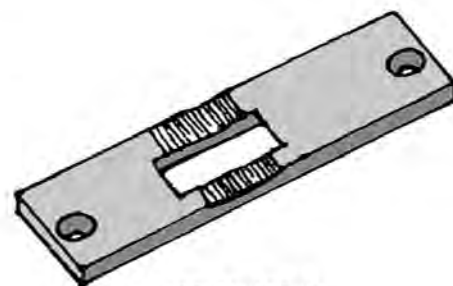

467-20-009-0  
Throat Plate

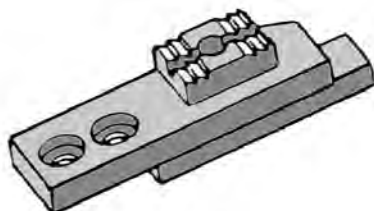

067-0  
067-21-028-0  
Feed Dog (67; 68 Class)

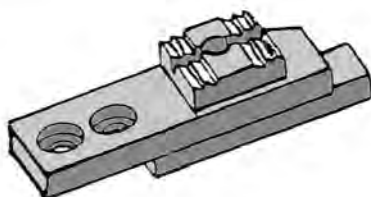

167-21-010-0  
Feed Dog. (167 Cl.)

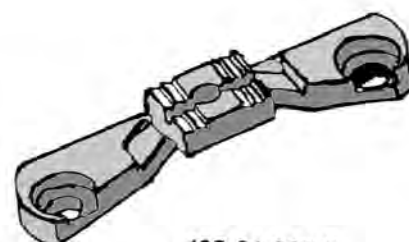

467-21-006-0  
Feed Dog

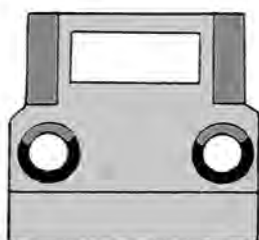

069-00-133-0

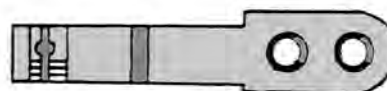

069-00-268

Placche e griffe ADLER-NECCHI-PFAFF per pelle , nella sezione trasformazioni per pelletteria

## ALFA

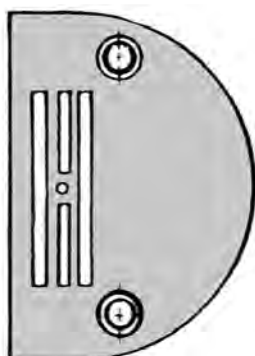

CONF. IN GENERALE  
MEDIA/PESANTE

83010  $\phi$  del paso de aguja 1,20 mm  
83011 Id 1,60 mm  
83012 Id 2 mm

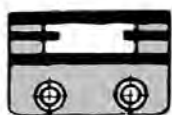

83175 Paso de dientes 1,16 mm  
83176 Id 1,50 mm  
83177 Id 2 mm

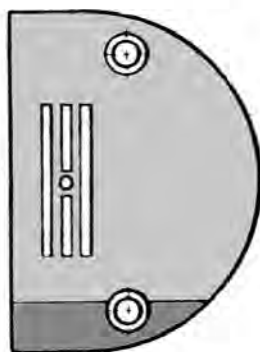

PER LAVORO LEGGERO,  
CAMICERIA E TESSUTI  
SINTETICI.

82005 -  $\phi$  del paso de aguja 1,2 mm



82105 - Paso de dientes 1,16 mm  
82107 - Dientes cruzados

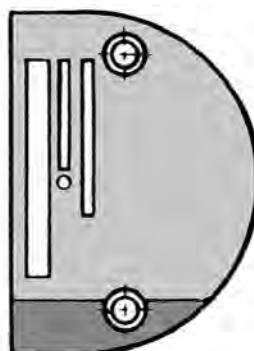

CONFEZIONE MEDIA,  
PANTALONI, GIACCHE  
E TRASPORTO PESANTE  
IN ABBIGLIAMENTO PELLE.

82003 -  $\phi$  del paso de aguja 2 mm



82103 - Paso de dientes 1,50 mm



CONFEZIONE PELLE  
IN GENERE

82002 - Id 1,6 mm



82102 - Paso de dientes 1,5 mm