

RICAMBI UNION SPECIAL

cl. 35800

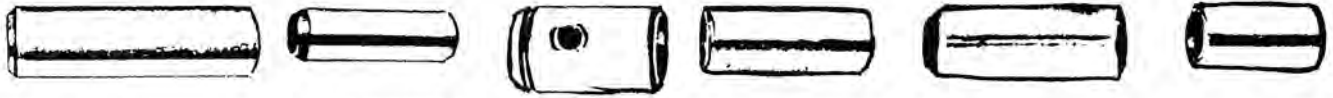

35731 F (bronzo)

35859 K (35759 A)
bronzo

35760 E (bronzo)

35831 G (bronzo)

35850 D (bronzo)

35859 L (35859 B)
bronzo



35848 B



35848 D



35848 E



22562 A



22564 D



35859 C (bronzo)



35859 D (bronzo)



35818 BY-9
(9 gauge)



605



35825 E



- # 35817 E



35796 B



35796 C



35870



35864 F



35830 K



35763 F - 625



35820 BQ-9
(9 gauge)

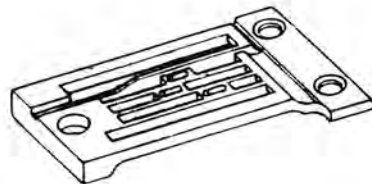

- # 35824 BQ 9 (9 gauge)

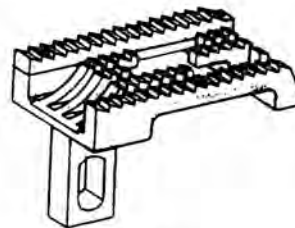

35805 BQ 9
(9 gauge)

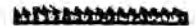

35826 E



35830 BX-8
35830 BX-9
35830 DM-9

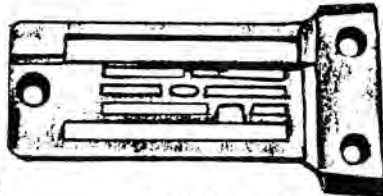

- # 35824 DQ-9 (9 gauge)

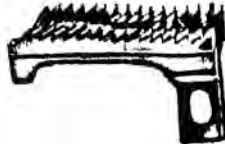

- # 35805 BR 8
(8 e 9 gauges)
- # 35805 DP 8
(8 e 9 gauges)



- # 35826 DP
(8 gauge)
- # 35826 DM
(9 gauge)



- # 35826
(8 e 9 gauges)



35820 AC-16

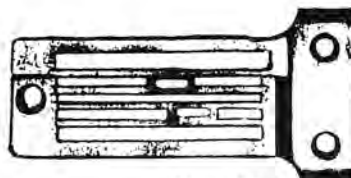

- # 35824 AC-16



- # 35805 AC-16

cl. 35800 AC

RICAMBI UNION SPECIAL

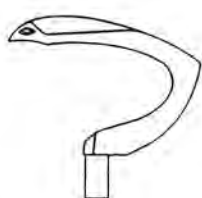

35809AY (AV)



35809BY (AY)



35808 AY (AU)

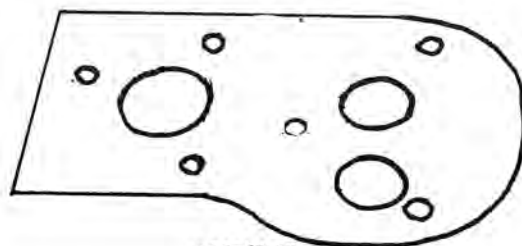

- # 35887 AD

cl. 36200

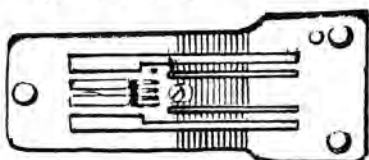

36224 A



36205 A

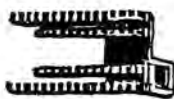

36226 A

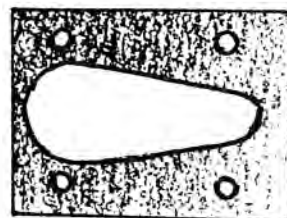

- # 35884 D

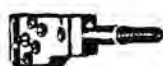

36218



36210



36248



22652 A 6



- # 36204



36279 C



- # 36249



36283 B



36237 F



36232 F - destro



36231 F - sinistro



36231 G



36232 G



36234 C



36251 E (A)

36232 Z (36232 E)
destro, allungato

36231 Z (36231 E)
sinistro, allungato

36232 D
destro, corto

36231 D
sinistro, corto



36270 HSS



CT 36270



36250 HSS



CT 36250



36240



G 36240



36208 A



G 36208 A



36230 D

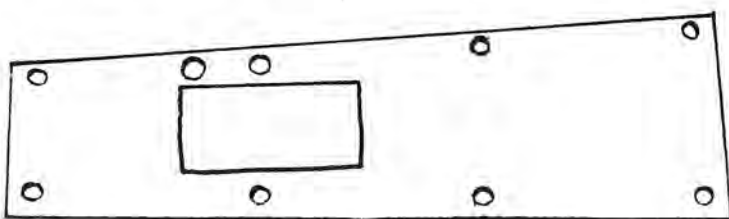

36283 F



36251 F



K 73512 (D)

RICAMBI UNION SPECIAL

cl. 39200

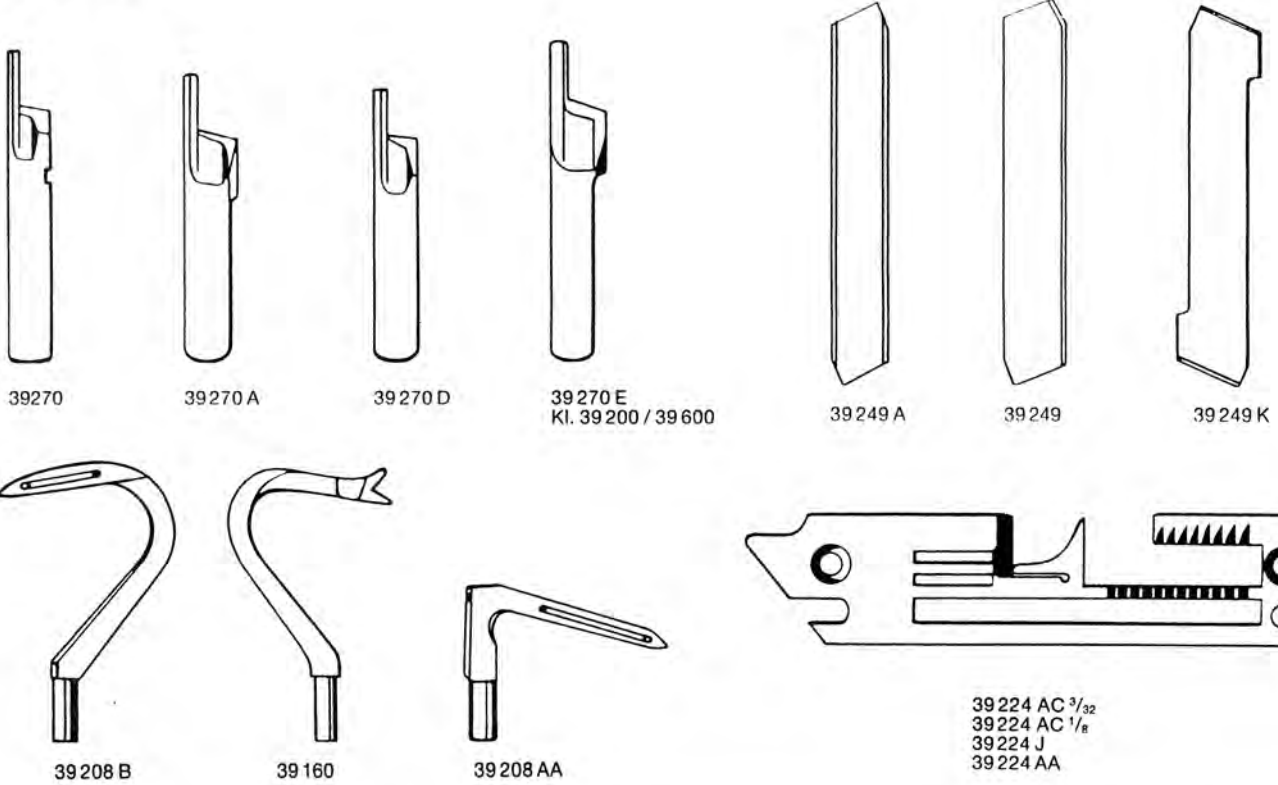

cl. 39500

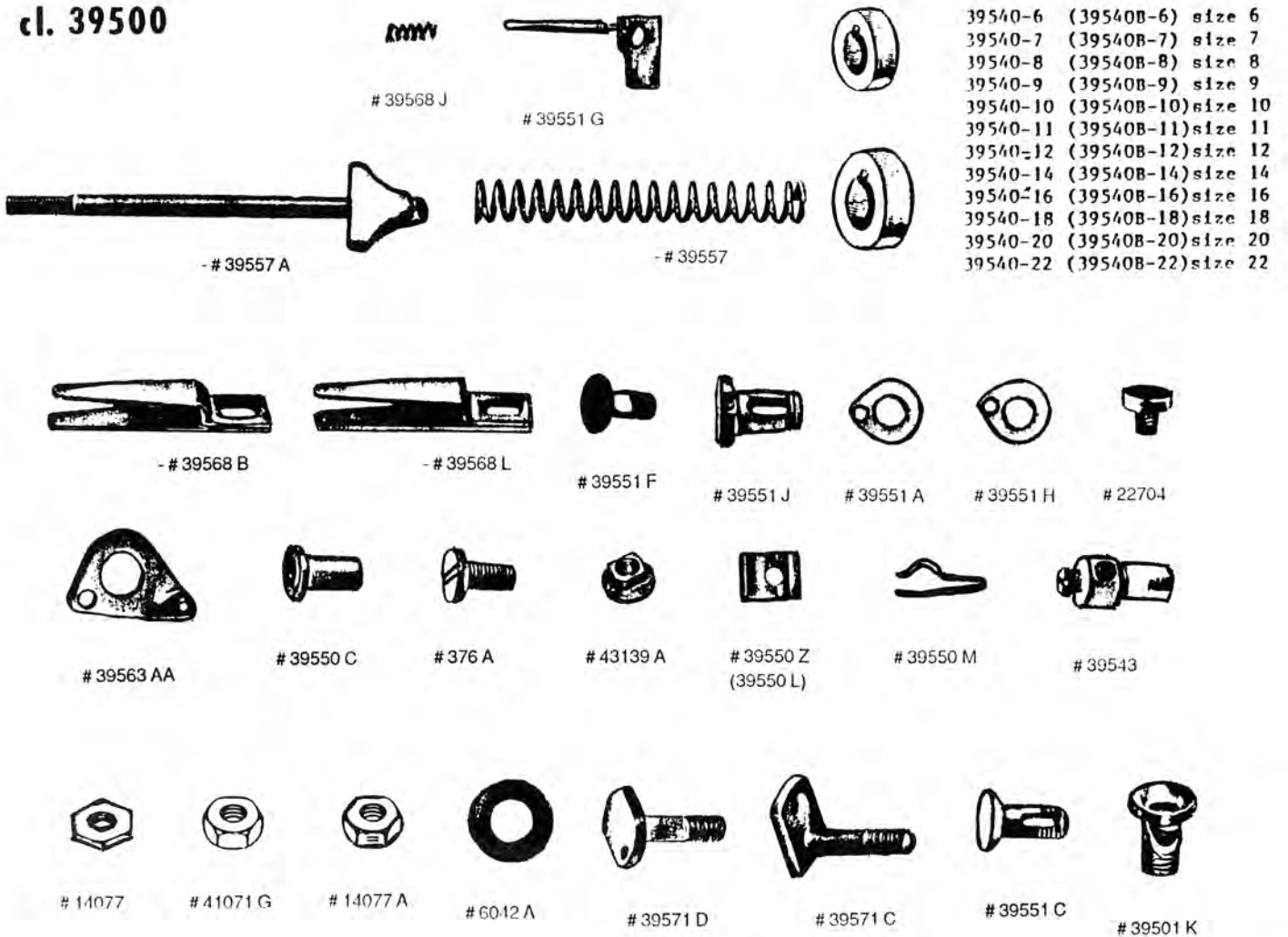

RICAMBI UNION SPECIAL

cl. 39500



#99672

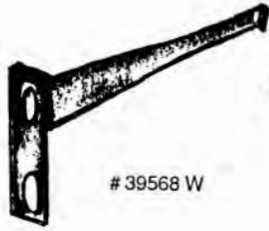

#39568 W



#39663 A



#39563 H



#39563 F



#39534



#39534 G

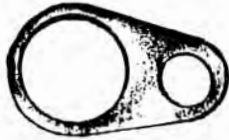

#39536 Z



#39536 C



- #39536 A
- #39536 AE



#39541 A



#39538



#39536 B



#39535 B
(39535 J)



#39568 E



#39552 AD



- #39563 G



- #39525 M



- #39525



- #39525 A



- #729



- #39525 N (39525 P)



- #39572



- #39572 A



- #39571 B



- #39550 E



#39563 W



#21227 BF

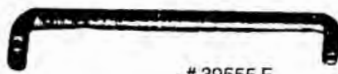

- #39555 F



- #35792 H



#109 D



#39571 F



#39543 M



- #39543 K



#39568 A



#39557 E



#39557 B



#39556 F



#39592 AD



- #51292 F-1 tens. crochet
- #51292 F-4 tens. crochet
- #51292 F-5 tens. ago
- #51292 F-8 tens. ago

RICAMBI UNION SPECIAL

cl. 39500



39521 PA



39594 H



39594 N



9593 C



- # 29481 H



39592 AF



39592 AH



39592 AL



8372 A



39592 AR-8
(39592 AE-8)



39543 T

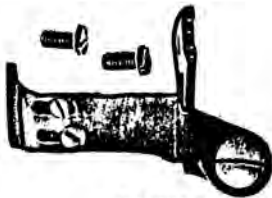

- # 29481 J

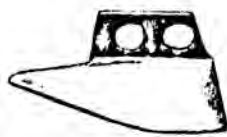

- # 39578 R



39578 P



22569 B



8372 A



39578 T



39578 U



51295 A



51295 B



- # 39532 A



- # 39582 AE

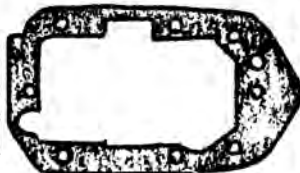

- # 39582 A

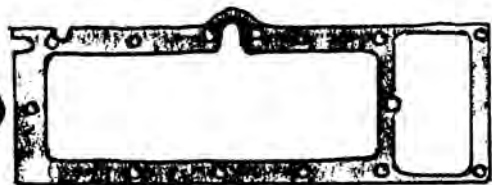

39582 Y



G 39570



CT G 39570



39570 SC
Solid carbide
Metal sólido duro



G 39570 A
(A 9181)



A 9392
(CT)



G 39570 JU
(A 9259)



CT G 39570 JU

RICAMBI UNION SPECIAL

cl. 39500



39570 J



CT 39570 J

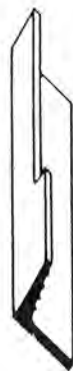

39570 K



39570 L



39556 K



39556 G



39549



G 39549 N
(A 9393)
(CT)



39549 SC
Solid carbide
Metal sólido duro



G 39549 JU
(A 9071)



G 39549 SU
(CT)



39549 J



CT 39549 J

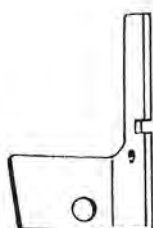

99669 K (GM)

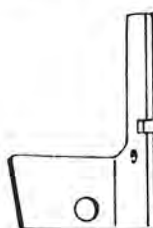

CT 99669 K (GS)
CT 99669 KH



99670 L



99669 (GC)



CT 99669

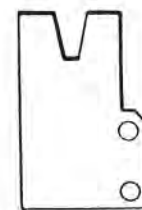

99670 (GD)



39508 A (CC)
G 39508 A (UM)



39508 E (CK)



G 39508 AV (GC)
(A 9050)

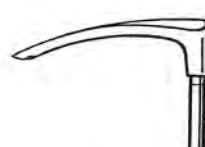

39508 C



39560 A (E)

RICAMBI UNION SPECIAL

cl. 39500



39 508 B



39 508 D



39 508 P



39 560 B

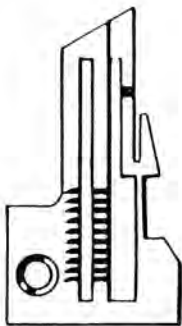

39 524 B $\frac{3}{32}$
(V $\frac{3}{32}$)

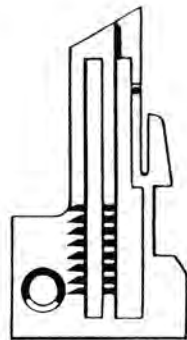

39 524 B $\frac{1}{8}$
(V $\frac{1}{8}$)

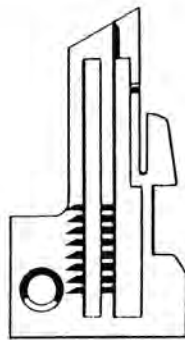

39 524 B $\frac{5}{32}$
(BH)

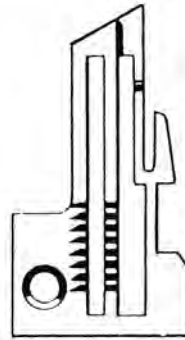

39 524 P
(A.J)

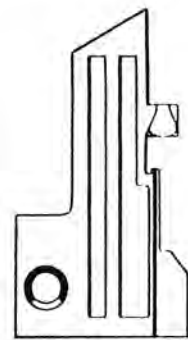

39 524 GA
(A 8924)

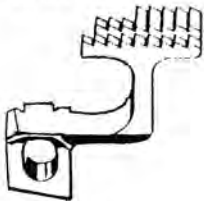

39 526 AW

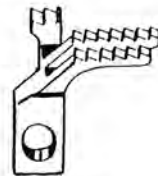

39 505 AW



39 505 B

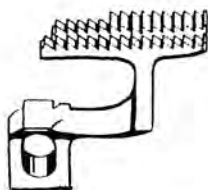

39 526 B

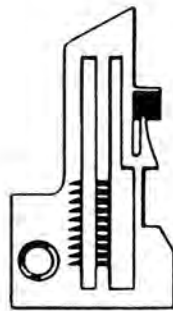

39 524 C $\frac{3}{32}$
(AC $\frac{3}{32}$)

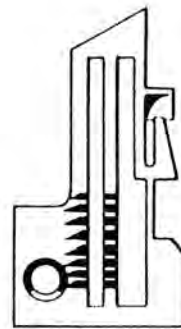

39 524 C $\frac{1}{8}$
(AC $\frac{1}{8}$)

39 524 C $\frac{5}{32}$
(AC $\frac{5}{32}$)

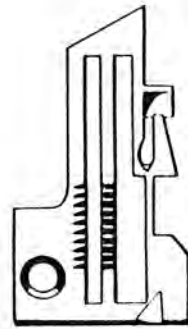

A 9953 $\frac{1}{8}$
(HV $\frac{1}{8}$)

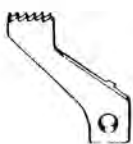

39 505 E

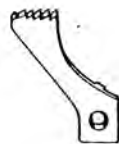

39 505 C

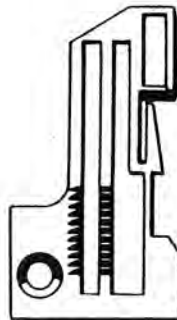

GA 39 524 C $\frac{3}{32}$ (HA)

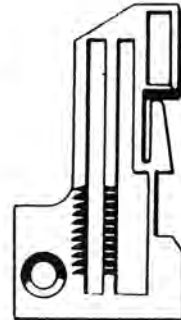

GA 39 524 C $\frac{1}{8}$ (HB)

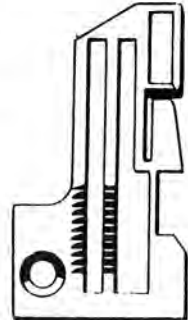

GA 39 524 C $\frac{5}{32}$ (HC)

RICAMBI UNION SPECIAL

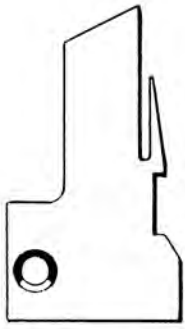

39 524 AB 1/8
(AX 1/8)
ohne Transporteurschlitz

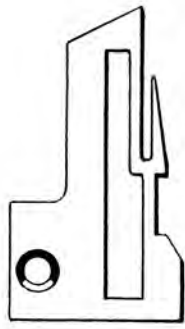

39 524 AB 1/4
(AX 1/4)

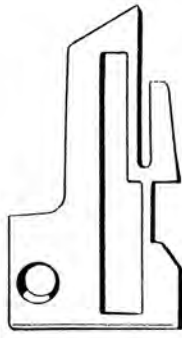

39 524 AB 5/32
(AX 5/32)

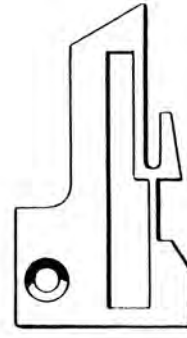

39 524 AC (AV)

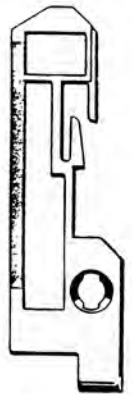

A 9608 B (HG)

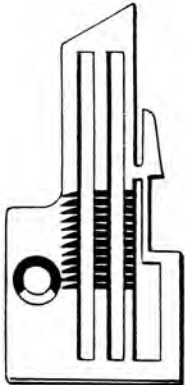

39 524 BF 1/8 (BK)

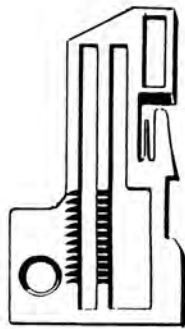

G 39 524 AV (GB)

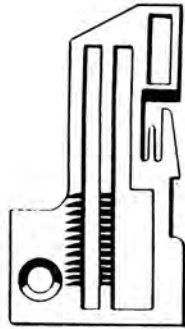

G 39 524 AW (GC)
GB 39 524 AW (HN)

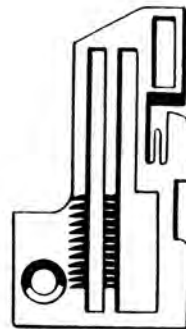

GA 39 524 AW (HH) 5/32

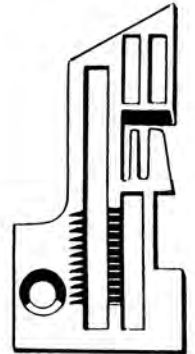

39 524 W (AN)

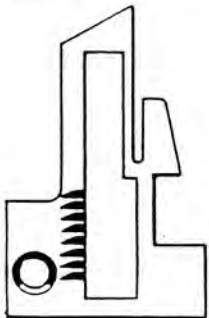

39 524 J

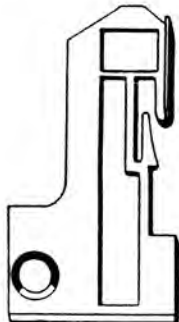

G 39 524 JU
(GI)

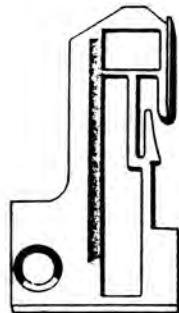

GA 39 524 JU
(HE)

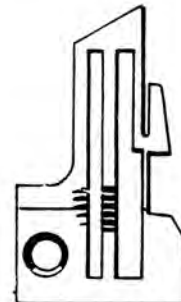

39 524 D (AM)

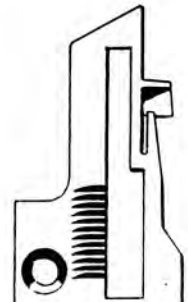

39 524 AS (BE)

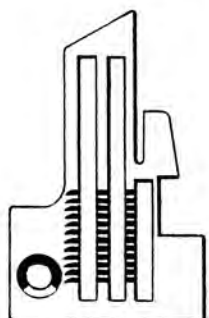

39 524 N (AH)



- # 39 526 AC
completa

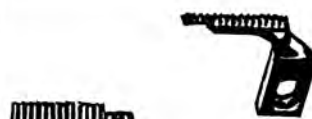

39 526 AC



39 505 P (J)



39 526 AA (AA)



39 505 E



39 505 F (F)



39 526 H



39 505 H (U)



39 505 S (R)



39 526 U (P)



- # 39 505 J/K
completa

RICAMBI UNION SPECIAL



- #39524 Y 1/8" (AS)



- #39524 T (AL)



#39520 T



#39520 P



#39505 P (J)



#39526 Y (AB)



#39505 P (J)



#39526 P



#39520 W



#39597 W



#39505 E



39520 N



#39520 A



#39520 B

FOR 39800AP, AQ

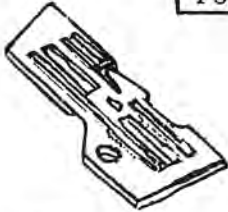

39828A-12-3/16
Throat plate



39826A
Diff. feeder



39826C
Diff. feeder

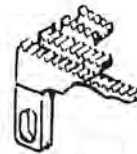

39805A-12-3/16
39805B-12-3/16
Main feeder

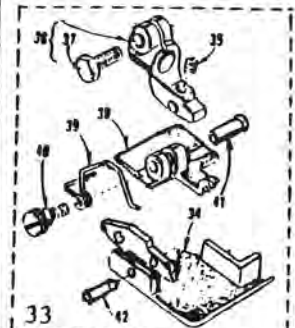

- 33 39820A-12 3/16 Presser foot.
- 34 39830C Foot bottom.
- 35 22733 Set Screw
- 36 39830 Foot shank.
- 37 22588A Clamp screw.
- 38 39830A Needle hole section.
- 39 39830S Spring.
- 40 39830F Hinge screw.
- 41 39830B Locknut screw.
- 42 39830E Hinge pin.

FOR 39800 AX, AY

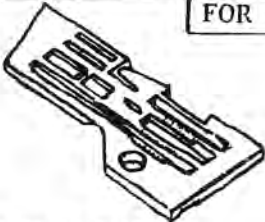

39828E-12-3/16
Throat plate



39826A
Diff. feeder



39826C
Diff. feeder



39805E-12-3/16
Main feeder

FOR 39800 AA, AB, AP, AQ

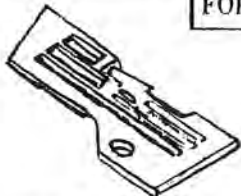

39828G-5-1/8
Throat plate



39626D
Diff. feeder



39805G-5-1/8
Main feeder



39820 A-5 1/8
Presser foot

Separate parts for 39820A-5-1/8

- 34 39830K Foot bottom.
- 36 39830G Foot shank.
- 38 39830H Needle hole section
- 41 39830J Locknut screw.



39808A



39808C

39808



39808D



39860

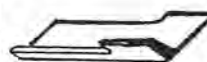

39870

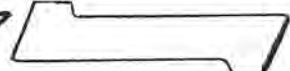

39849

RICAMBI UNION SPECIAL

GAUGE SETS FOR 51400 BP



51420-8 (1/8" Gauge)
51420-12 (3/16" Gauge)
51420-16 (1/4" Gauge)
Presser Foot with Channels

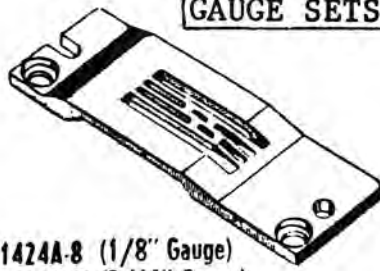

51424A-8 (1/8" Gauge)
51424A-12 (3/16" Gauge)
51424-16 (1/4" Gauge)
Throat Plate



51405A-8 (1/8" Gauge)
51405A-10 (3/16" Gauge)
51405-16 (1/4" Gauge)
Feed Dog,



51420C-8 (1/8" Gauge)
51420C-12 (3/16" Gauge)
51420C-16 (1/4" Gauge)
Presser Foot with Flat Bottom

GAUGE SETS FOR 51400BX



51420K-24 (3/8" Gauge)
Presser Foot with Flat Bottom

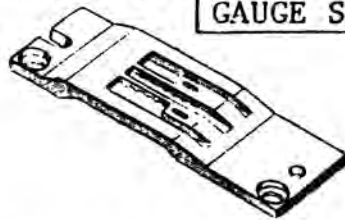

51424K-24 (3/8" Gauge)
Throat Plate



51405K-26 (3/8" Gauge)
Feed Dog

BACK LOOPERS



51409



51409B

FRONT LOOPERS



51408-8 (1/8" Gauge)
51408-12 (3/16" Gauge)
51408-16 (1/4" Gauge)
51408-24 (3/8" Gauge)
51408-32 (1/2" Gauge)

For 51700



51709



51708

LAP SEAM FOLDER



23420V-3/16M 23420V-1/4M
23420V-3/16MH 23420V-1/4MH
23420V-3/16H 23420V-1/4H
23420V-3/16XH 23420V-1/4XH

GAUGE SETS FOR 51800

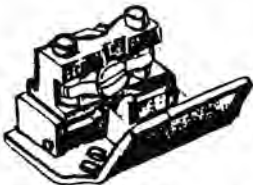

51820-16-64-16 Presser Foot
51820-12-56-12

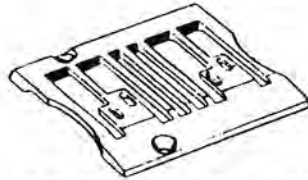

51824-16-64-16 Throat Plate
51824-12-56-12



51805-16-64-16 Feed Dog
51805-12-56-12

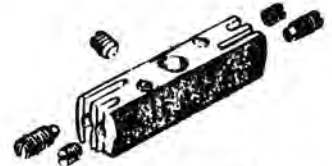

51818-16-64-16 Needle Holder
51818-12-56-12

GAUGE SETS FOR 51900 BH



35820P-9
Presser Foot



51924B-9
Throat Plate



51905B-9
Feed Dog

LOOPERS



51808 Front



51809 Back



51808A Front

GAUGE SETS FOR 51900 BJ



35820R-9
Presser Foot

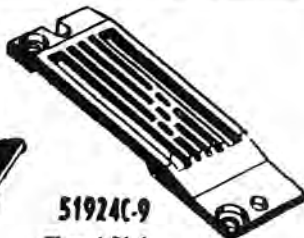

51924C-9
Throat Plate



51905C-9
Feed Dog

LOOPERS



51908B-9
Front



51909C
Middle



51909D-9
Back

RICAMBI UNION SPECIAL

52700, 52800, 52900
57700, 57800

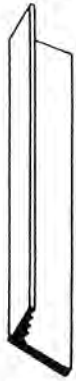

52970 E



A 9464 = 52970 D
(CT)



52949 A



CT 52949 A



52949



52970 C



CT 52970 C

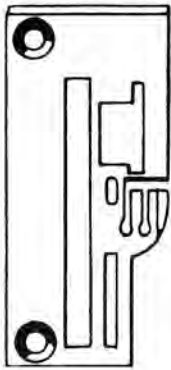

G 52928 A 5-8

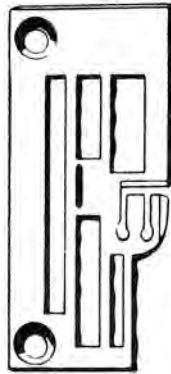

52928 A 16-8

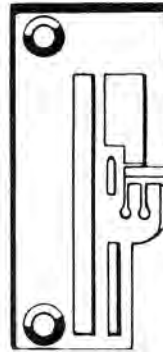

52924 BH 5-8

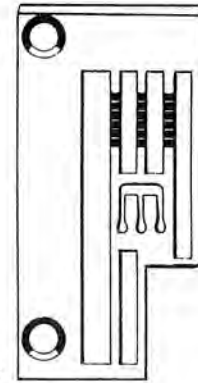

*

C 52824 N-16

52700



52770 C (B)
52770 D (E)
CT 52770 C



52749 A

52700 BKZ Galkin

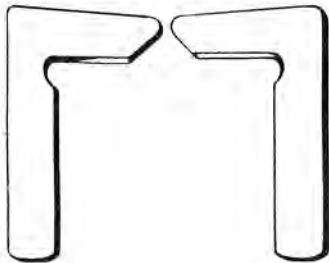

167 L
CT 167 L

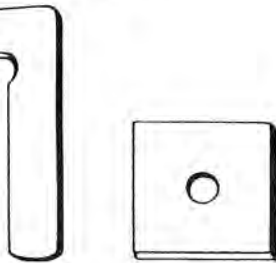

168 R
CT 168 R

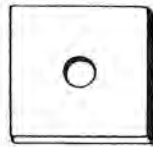

169

51400, 52300, 52900, XF 500



51470



J



CT 51449

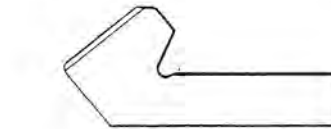

A 9540

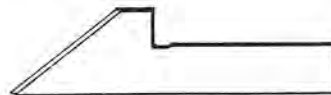

52949 B

54200, 54400



*

54208 B



54211 A

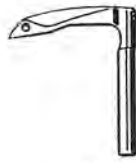

54208 (BZ)

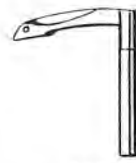

54208 A (CB)

53100



G 53170 R



9949 AR

RICAMBI UNION SPECIAL

52800 BA, BD, BP, BR, BS, BY, BU, BV



13120F-8
Presser foot



52820H-8
52820H-12
Presser foot

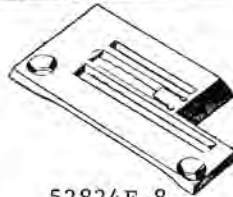

52824F-8
52824F-12
Throat plate



5026A
Diff. feeder



52805F-8
Main feeder

52800BW



52820K-16
Presser foot

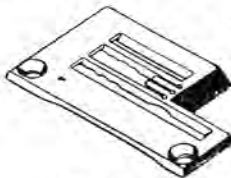

52824K-16
Throat plate



52826K
Diff. feeder



52805K
Main feeder

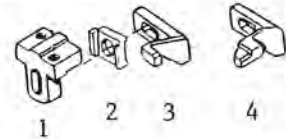

- 1 52853 Feed dog holder
- 2 52925D Needle guard holde
- 3 52825B Rear needle guard
- 4 52825A Rear needle guard
- 52825E Rear needle guard

52800BX



52820X-16
Presser foot



52824X-16
Throat plate



52826H
Diff. feeder



52805X-16
Main feeder

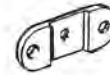

23432
Folder clamp



52864N
Folder suppor
bracket

52800BN



5127H
(G52827-16)
Presser foot

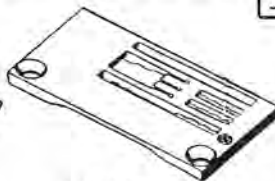

52824D-16
Throat plate



3026A
Diff. feeder



52805D-16
Main feeder



56958 (51958)
Needle lever
thread eyelet



56958A (51958)
Needle bar
thread eye

OTHER PARTS FOR 52800, 57800

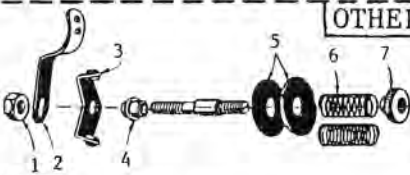

- 1 43266 Nut
- 2 51491C Thread lead-in guide
- 3 51292D Tension thread eyelet
- 4 51292A Tension post ferrule
- 5 109 (109D) Tension disc
- 6 51292F-1, 2, 4, 5, 8,
Tension spring
- 7 51292C Tension nut

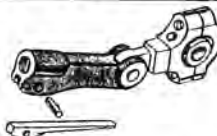

52941F
Looper connecting rod
section and ball joint
assembly, Right



52804A (52804)
Cast off plate, Wire



51458 (56458A)
Needle bar
thread eyelet



158B
Thread guide



51758
Thread guide



52904G
Cast off, Wi



52708B
Looper



52845A
Spreader

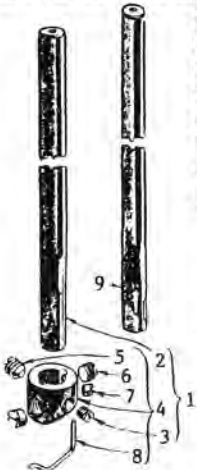

- 1 29264S-16 N.bar assembly
- 2 52817-16 Needle bar only
- 3 28C Screw
- 4 52818-8 Needle clamp
- 5 89 Screw, spot
- 6 88B Screw, needle
- 7 52842G Thread guide, wire
- 8 28B Screw
- 9 52817E-8 Needle bar only
- 52717E-12 Needle bar only

RICAMBI UNION SPECIAL

53100B, C

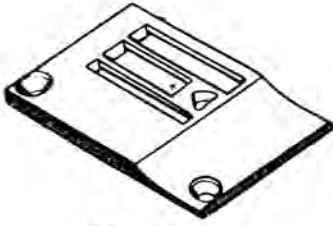

53124B
Throat plate



53105B
Feed dog



53108C
Looper assembly



53117A Needle bar
56N (56) Needle clamp nut



79220A
Presser foot

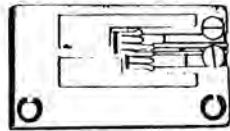

79228A Throat plate

79230H Stitch tongue, center
79230G Stitch tongue, left
79230D Stitch tongue, right

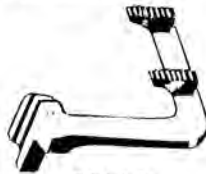

53426A
Diff. feeder



53405A
Main feeder

53400

LOOPERS

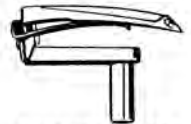

53407C (53407)
Front looper

53411B
Thread retainer spring

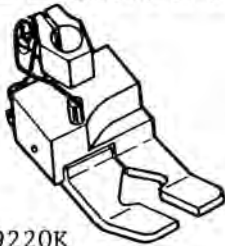

79220K
Presser foot

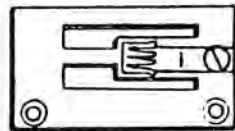

79224K Throat plate

79230K Stitch tongue

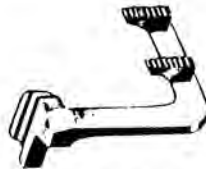

53426K
Diff. feeder



53405K
Main feeder



53409C (53409)
Rear looper

53411C
Thread retainer spring

OTHER LOOPERS



52808E



52908B

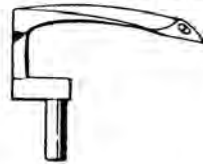

52909A

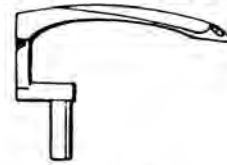

52909E-16



51909C (51909B)



51509C



51508-16
(51508M-16)



51508-18
(51508M-18)



51208



51208Y



51409C



52708B



52708A



5107H



33709A



9907



2108



AS26XA











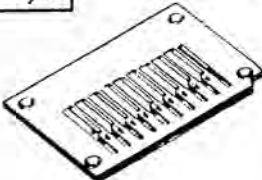

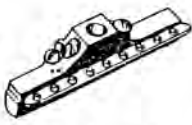

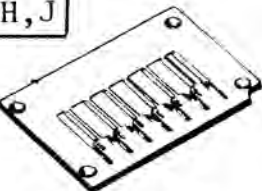



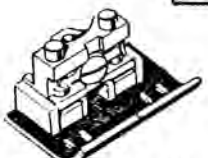
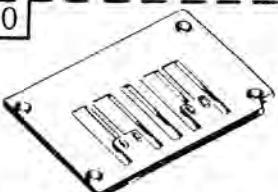

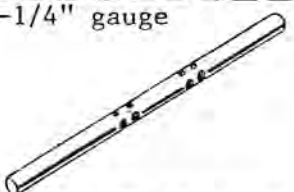
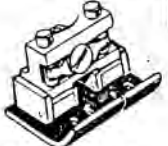
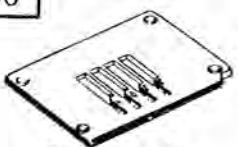

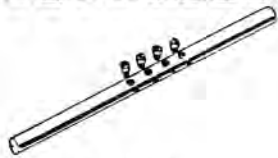















81208

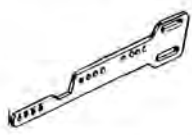

19307

RICAMBI UNION SPECIAL

54400H,J		9-needle 16(1/4")gauge		
				
54420-9-16 Presser foot	54224A-9-16 Throat plate	54205A-9-16 Feed dog	59218-9-16 (54418-9-16) Needle holder	54242B-9-16 Retainer holder
54400H,J		12-needle 12(3/16")gauge		
				
54420-12-12 Presser foot	54224A-12-12 Throat plate	54205A-12-12 Feed dog	52918-12-12 (54418-12-12) Needle holder	54242B-12-12 Retainer holder
54200		4-needle UNEQUAL SPALE 1/4"-1"-1/4" gauge		
				
54220A-16-64-16 Presser foot	54224A-16-64-16 Throat plate	54205A-16-64-16 Feed dog	16154-16-64-16 Needle holder	54242B-16-64-16 Retainer holder
54200		4-needle EQUAL SPACINGS		
				
54220A-4-16 54220A-4-21 54220A-4-24 54220A-4-32 Presser foot	54224A-4-16 54224A-4-21 54224A-4-24 54224A-4-32 Throat plate	54205A-4-16 54205A-4-21 54205A-4-24 54205A-4-32 Feed dog	54218-4-16 54218-4-21 54218-4-24 54218-4-32 Needle holder	54242B-4-16 54242B-4-21 54242B-4-24 54242B-4-32 Retainer holder
LOOPER HOLDER		THREAD EYELETS FOR 54200,54400		
				
54485A	54485	54485A-4-16	54158	54158A
				
		1068	54459B	
				
54458-9	54458A-9	54459A-9	54458B-9	54458-12
				
		54458A-12	54459A-12	54458B-12
				
54492A	51292D	54459-12		
				
		54458C-9	54458C-12	16197-2-16
				
54491	51491C	16197-4-16 16197-4-21 16197-4-24 54458D-4-32		

RICAMBI UNION SPECIAL

PARTS FOR UNION SPECIAL

For 54200, 54400



54208A
Looper



54208B
Looper



54225
Needle guard



54211A
Retainer



54285C
Nut



54244P
Looper holder frame



51295A
Mounting isolator



51817A
Needle bar



51454B
N.bar connection

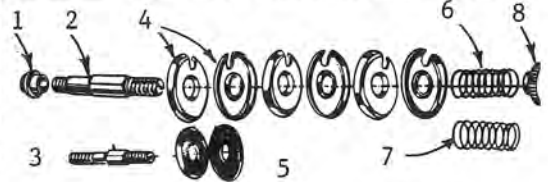

- 1 51292A Tension post ferrule
- 2 54492B Tension post
- 3 51292G Tension post
- 4 109(109D) Tension disc
- 5 54492 Tension disc
- 6 51292F-5 Tension spring
- 7 51292F-1 Tension spring
- 8 51292C Tension regulating nut

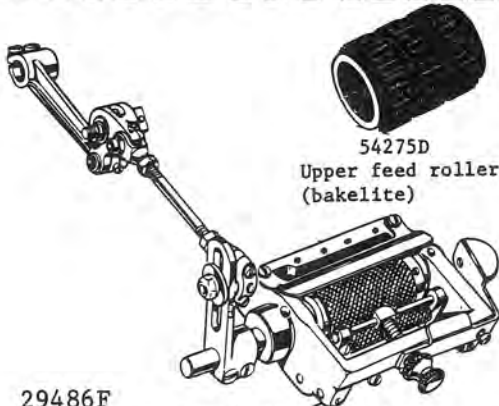

29486F
Elastic metering device, complete



54275D
Upper feed roller
(bakelite)



54275E
Upper feed roller
(rubber)



54276
Lower feed roller
(bakelite)



54276A
Lower feed roller
(rubber)



54492C
Tension post ferrule

POPULAR SCREW FOR 54200, 54400



28C



73A



80



87



88



91



93



97A



98A



605A



22570A



22574



22585C



22596



22764A



22768



22845B



22848



22894P



J87J

CORK GASKETS



52882P
Crank chamber cover
(upper) gasket



52882M
Back cover gasket



51382A
Oil reservoir
top cover gasket



51282Z
Face plate gasket



51493BG
Felt gasket

RICAMBI UNION SPECIAL

81200, 80200, 80600, 80800



AS 26XA



81208

81500, 81300

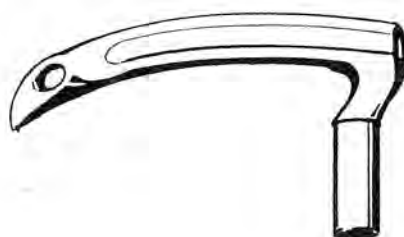

81508

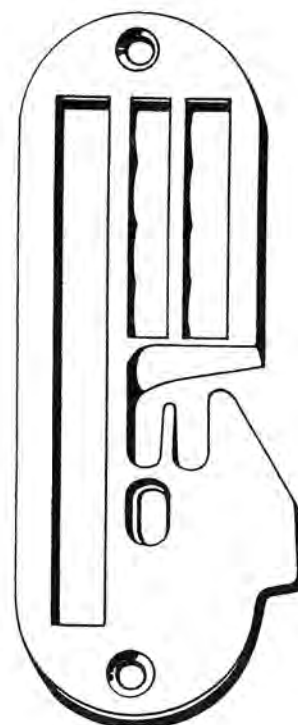

81224 AB

Z 1000, ZF 1000, Z 1500 Series
 Z 2000, Z 3000, Z 5000, Z 6000 Series
 AZ 6000, AZ 8000, AZ 8500 Series
 AZF 8400, AZF 8600 Series

RICAMBI YAMATO



20491



20491N



20491S

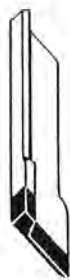

202003
(CT)



20496
(CT)



23580
(CT)

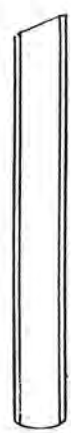

20498



22195



23582



2100167



2110305



20271

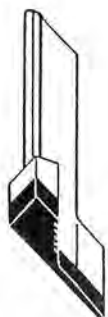

2121107
(CT)



2121111

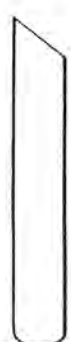

2101091



35285



35286
35211(CT)

RIEPILOGO LOOPERS UNION SPECIAL (importazione)
 la produzione MAIER è nelle pagine successive

made in taiwan

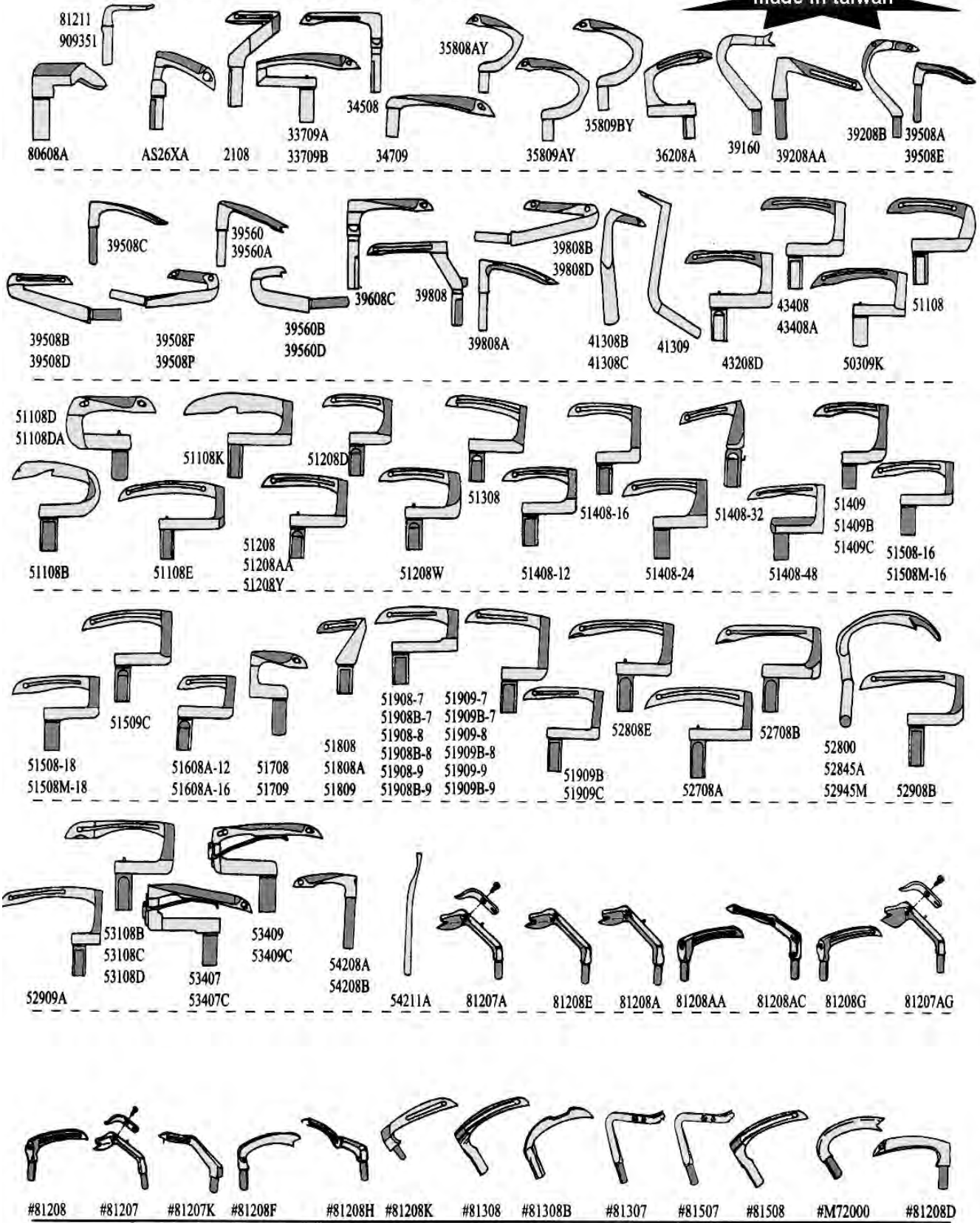

Vi ricordiamo che su richiesta , siamo in grado di fornire anche ricambi originali di tutte le marche principali : in particolare, PFAFF – REECE –AMF STROBEL – MAUSER PEGASUS – JUKI - UNION SPECIAL – UNITAS – SIRUBA – KANSAI con listino ufficiale