

# RICAMBI PFAFF

q

q

q ff

I)

## PFAFF KL. 138 - 238 - 438



64594 barra ago

700868 vite ago

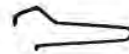

069457 molla perno filarello



06584 molla conica



061087 tensione



105447 staccadisco



002065 disco tensione



010026 part.tensione



009609



006818 staccadisco



069231 scartafilo



168498



168499



167973



167350



168300



150166



150446



118099 filarello cpl

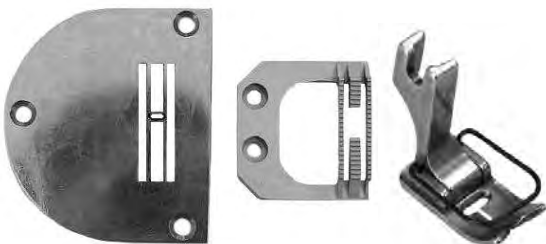

**VEDERE LE SEZIONI RELATIVE**

# RICAMBI PFAFF

FOR 145

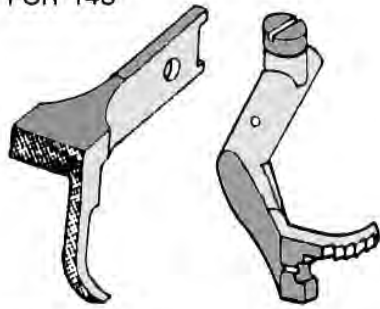

40432-8.0 A/B  
Outside Foot

40629X5.0 B  
Inside Foot

GAUGE SET FOR "PFAFF" MACHINES



91-000407-15  
Feeder Screw



91-000073-35  
Presser Foot Screw



91-000422-35  
(42235)  
Plate Screw



91-010023-05  
(10023)  
Thread Take-Up Spring



91-010028-35  
(10028)  
Thread Guide (Front)



91-000666-05  
Tension Stud



91-006505-05  
(6505)  
Tension Disc

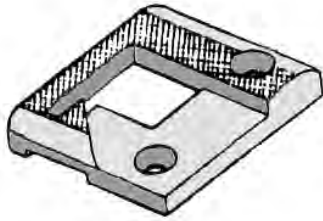

46498  
Throat Plate

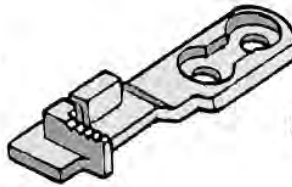

46497 B  
Feed Dog

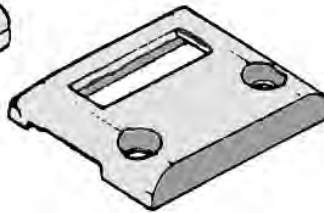

46498 S  
Throat Plate

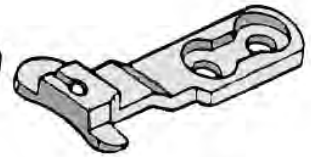

46497 S  
Feed Dog

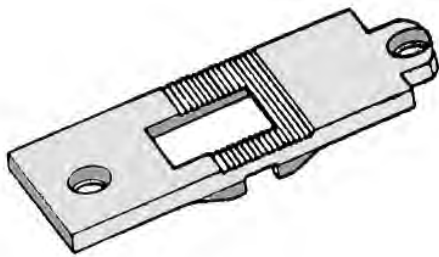

91-026746-04C  
(26746C) Throat Plate

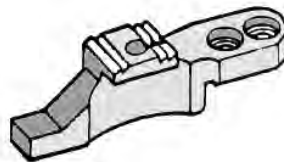

91-026745-04B  
(26745B) Feed Dog



91-026745-04C  
(26745C) Feed Dog

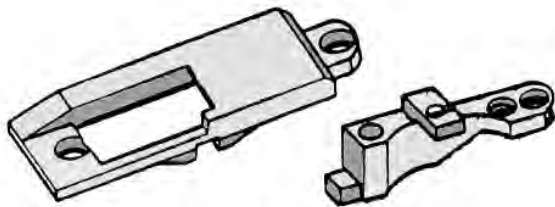

91-045592-04C  
(45592C) Throat Plate

91-045591-04C  
(45591C) Feed Dog

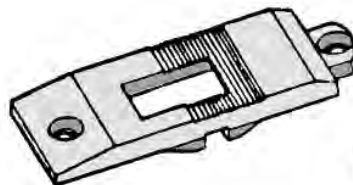

91-048537-04 C/D  
848537C/D) Throat Plate



91-047181-04C  
(47181C) Feed Dog

FOR 145



91-710650-92 (10650)  
Needle Bar



91-011718-92 (11718)  
Presser Bar

# RICAMBI PFAFF

FOR 145

GAUGE SET FOR "PFAFF" MACHINES



91-049544-04 x 3.0 (49544 1/8")  
 91-049544-04 x 4.0 (49544 5/32")  
 91-049544-04 x 5.0 (49544 3/16")  
 91-049544-04 x 6.0 (49544 1/4")  
 91-049544-04 x 6.0 (49544 5/16")  
 91-049544-04 x 9.6 (49544 3/8")  
 Outside Foot  
 91-049047-93 x 3.0 (49047 1/8")  
 91-049047-93 x 4.0 (49047 5/32")  
 91-049047-93 x 5.0 (49047 3/16")  
 91-049047-93 x 6.0 (49047 1/4")  
 91-049047-93 x 8.0 (49047 5/16")  
 91-049047-93 x 9.0 (49047 3/8")  
 Inside Foot

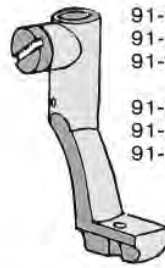

91-042442-93 x 3.0 (42442 1/8")  
 91-042442-93 x 5.0 (42442 3/16")  
 91-042442-93 x 6.0 (42442 1/4")  
 Inside Foot  
 91-042443-93 x 3.0 (42443 1/8")  
 91-042443-93 x 5.0 (42443 3/16")  
 91-042443-93 x 6.0 (42443 1/4")  
 Outside Foot

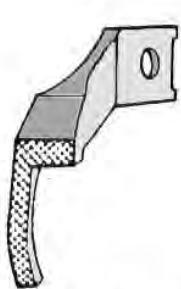
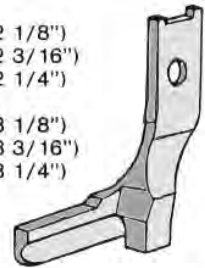

91-049558-04C/D  
 (49558C-D)  
 Outside Foot

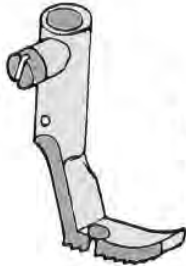

91-049085-93C  
 (49085-C)  
 Inside Foot

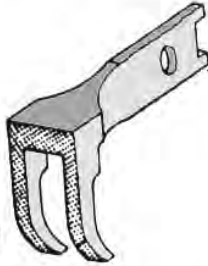

91-046970-04  
 (46985-C)  
 Outside Foot

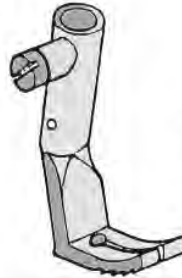

91-040474-93x40  
 (40474-4)  
 Inside Foot

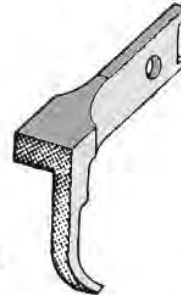

91-040475-04 x 5.0  
 (40475-5)  
 Outside Foot

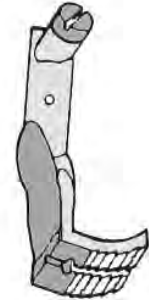

91-040474-93 x 5.0  
 (40474-5)  
 Inside Foot

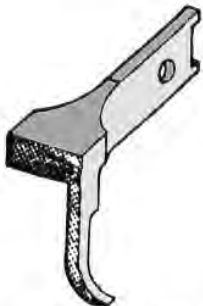

91-040475-04 x 6.0  
 (40475-6)  
 Outside Foot

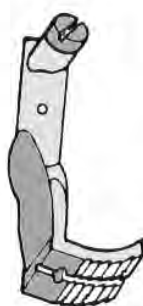

91-040474-93 x 6.0  
 (40474-6)  
 Inside Foot



91-040475-04 x 8.0  
 (40475-8)  
 Outside Foot

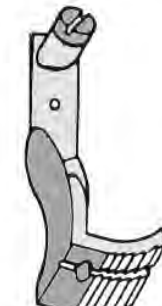

91-040474-93 x 8.0  
 (40474-8)  
 Inside Foot



91-044227-04  
 (44227)  
 Outside Foot



91-042819-93 x 8.0  
 (42819)  
 Inside Foot

FOR 142

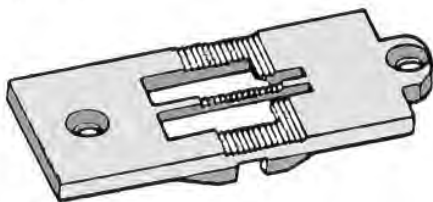

91-046715-04 x 3.0 A/B (46715 1/8")  
 91-046715-04 x 4.0 A/B (46715 5/32")  
 91-046715-04 x 5.0 A/B (46715 3/16")  
 91-046715-04 x 5.5 A/B (46715 7/32")  
 91-046715-04 x 6.0 A/B (46715 1/4")  
 Throat Plate

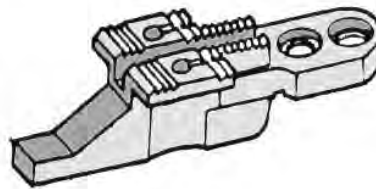

91-046714-30x3.0 A/B (46714 1/8")  
 91-046714-04x4.0 A/B (46714 5/32")  
 91-046714-04x5.0 A/B (46714 3/16")  
 91-046714-04x5.5 A/B (46714 7/32")  
 91-046714-04x6.0 A/B (46714 1/4")  
 Feed Dod



91-040811-03 x 3.0 A/B (40811 1/8")  
 91-040811-03 x 4.0 A/B (40811 5/32")  
 91-040811-03 x 5.0 A/B (40811 3/16")  
 91-040811-03 x 5.5 A/B (40811 7/32")  
 91-040811-03 x 6.0 A/B (40811 1/4")  
 Presser Foot



91-710005-93 x 3.0 A/B (710005 1/8")  
 91-710005-93 x 4.0 A/B (710005 5/32")  
 91-710005-93 x 5.0 A/B (710005 3/16")  
 91-710005-93 x 5.5 A/B (710005 7/32")  
 91-710005-93 x 6.0 A/B (710005 1/4")  
 Needle Bar & Clamp

numerosi altri ricambi PFAFF  
 nelle seguenti sezioni:

**CROCHET ROTATIVI** da pag. 110 ~ 114  
**PIEDINI PFAFF** pag. 120 - 139 ~  
**COLTELLI PFAFF** pag. 577  
**PLACCHE E GRIFFE PFAFF** pag. 160 ~ 164

# RICAMBI PFAFF

PFAFF 145 - 146



174086  
vite ago

010650  
barra ago



0034-15  
vite piedino

011718  
barra piedino



010050  
ingranaggio



010364  
ingranaggio



10027  
guidafilo



010060-34

00509  
vite per ingranaggi



10028  
guidafilo



000524



001522



006505



011264



010026



000666



011754

## RICAMBI PFAFF da KL 191 - 463 - 480 - 1183 - 3116 - 3307



174279



069794



069960



069160



118099



020316



020315



008648



175540  
165505



171853



264338



014046  
kl 335-337



171874



174481

## BARRE AGO E BARRE PIEDINO PFAFF



**006775** barra ago kl 34



**069794** barra ago kl 461-463-563-953-951



**119440** barra ago kl 471-493



**710650** barra ago kl 145-335-1295



**761011** barra ago kl 234



**710005** barra ago 3,2/4,8/6/6,4 kl 142-1242-542-194-442



**715538** barra ago kl 194-294-594



**006523** barra piedino kl 34-134



**011718** barra piedino kl 335-545



**063120** barra piedino kl 138-234



**119503** barra piedino kl 471-491-493



**174279** barra piedino kl 481-483



**541985** barra piedino kl 9020



**025369** barra piedino cpl kl 34-134



**061241** barra piedino kl 234 pelle



**109632** barra piedino kl 194-294-594-1294



**169319** barra piedino kl 461-463-561-563 pelle



**171075** barra piedino kl 483 pelle

# RICAMBI PFAFF



119455



119486



164672



058309 – 1,2AX4,5



011957  
kl 194-900



164925



176357



176093



176094



176098



186659



186661



266584



166700x7 – 9 – 12  
166701x7 – 9 – 12



173197  
kl 441-442



165642



165641



264338



169239  
x0,8 x1,0



262184

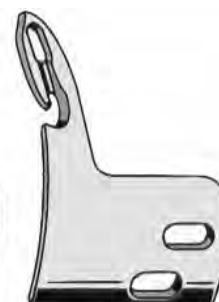

264240

# RICAMBI PFAFF

**3114, 3116, 3117, 3119, 3527**

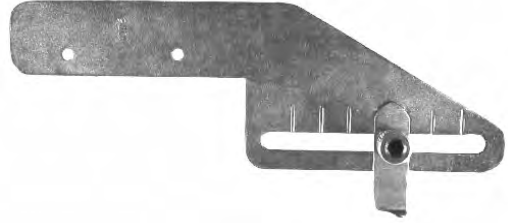
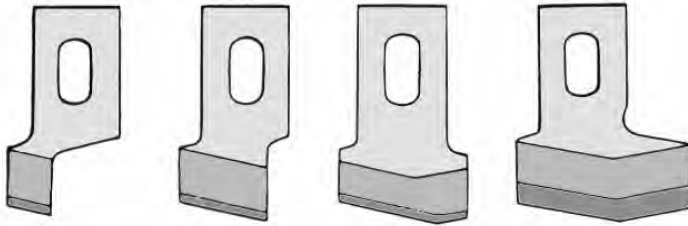

**P046646NO** spaziatore per asole kl 3114 - 3116

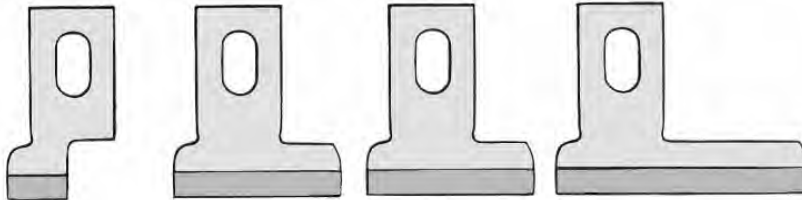

**A2351** coltelli normali  
**A2351M** versione **MAIER**  
Misure da mm 6,4 a mm 32

**A2352** coltelli dritti per seta  
**A2352M** versione **MAIER**  
Misure da mm 6,4 a mm 32

**KL 3334-3335-3337**

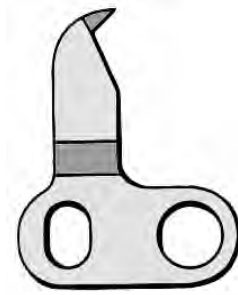

**022452**

**022453**

**022096**

**130182**

**130183**

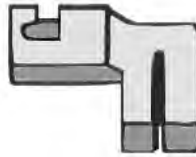

**182344**

**065546**  
**065543**

**P021559NO**  
morsetto grezzo



**108084** vite coltello mobile  
**108171**  
**108174** kl 442  
**108177** kl 442  
**174086** vite ago kl 145-335  
**330085** vite ago kl 481-483  
**000073-25** vite piedino kl 463-483  
**000219**  
**000407-15** vite griffa kl 145-463-483  
**000422-25** vite placca kl 145-242



**000422-35** vite placca kl 463  
**000509-15**  
**000785-05**  
**001179-15**  
**700335-15**  
**100296** vite placca kl 481-483  
**700112-25** vite per guide  
(precisare diametro in sezione)  
**700868** vite ago kl 138-238-438  
**700991-15**  
**701179-15** vite ago kl 463-481-483  
**701344-35**



# RICAMBI PFAFF

Su richiesta sono fornibili  
tutti i ricambi originali  
**PFAFF**

**Gruppo filarello frontale  
Pfaff 463**

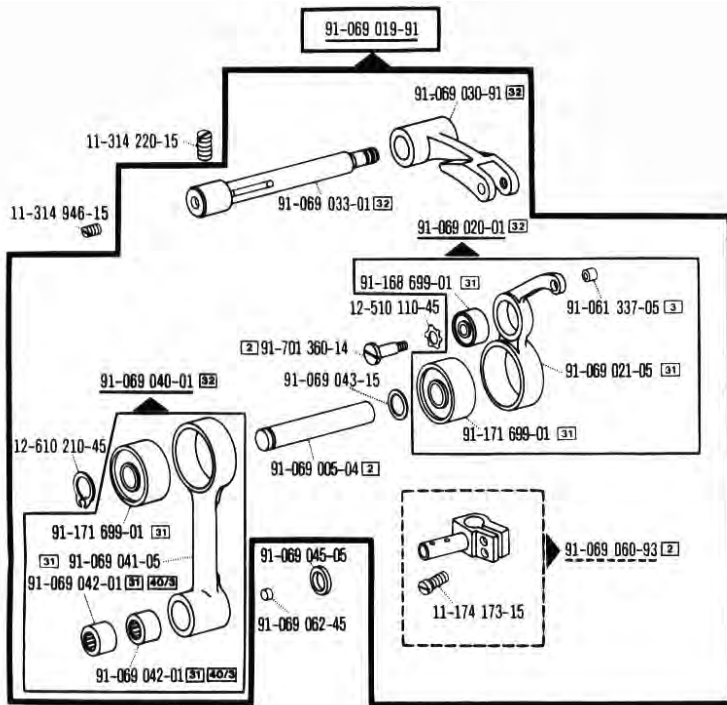
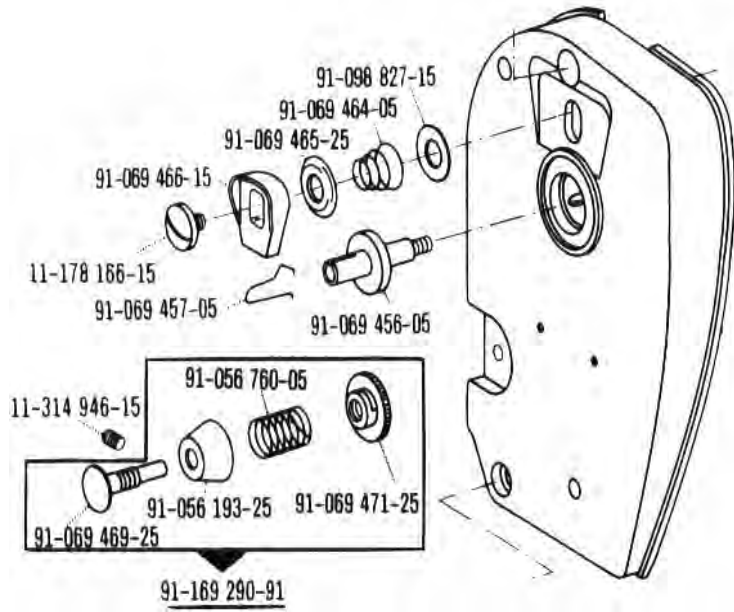

**Gruppo tendifilo  
Pfaff 463**

**Gruppo crochet  
Pfaff 463**

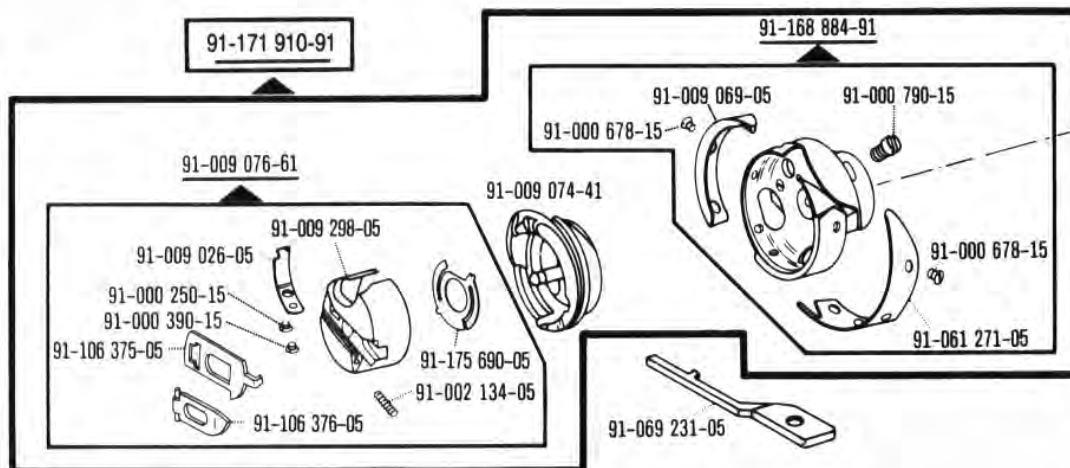



# RICAMBI PFAFF

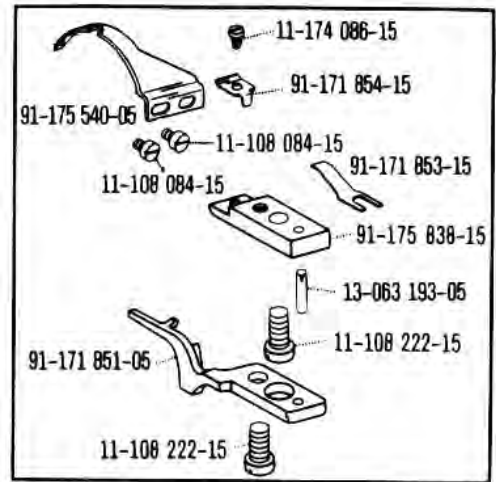
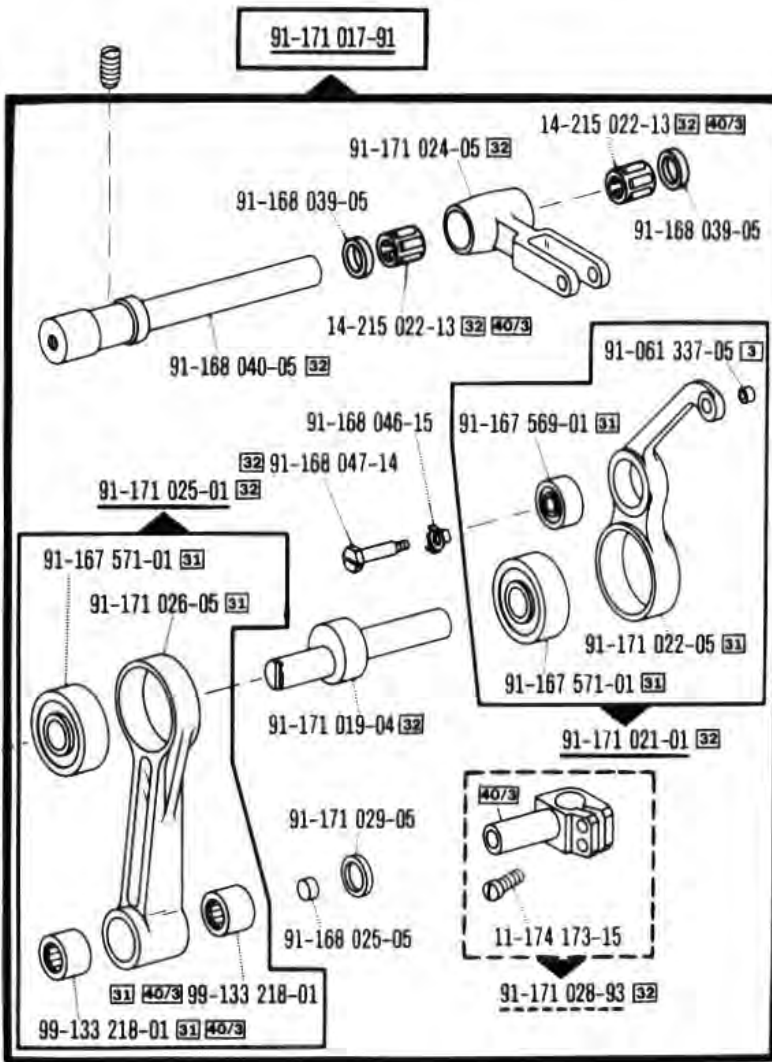

**Gruppo rasafilo  
Pfaff 463 - 483**

**Gruppo tendifilo  
PFAFF 483**

**Gruppo filarello  
Pfaff 483**

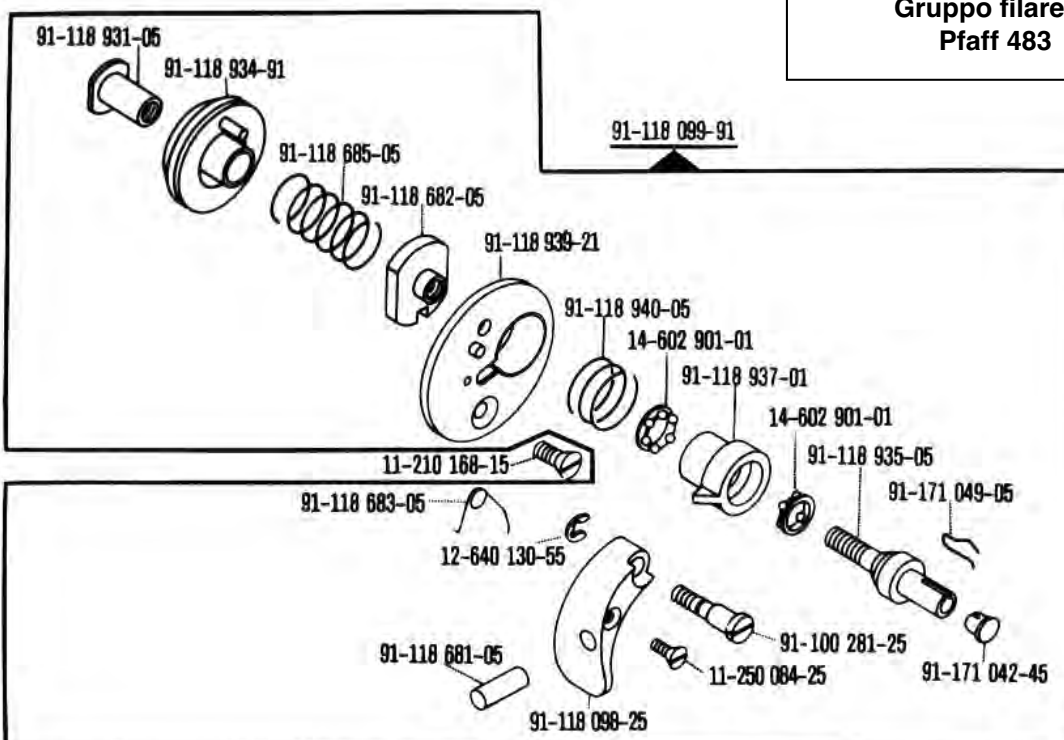

# RICAMBI PFAFF

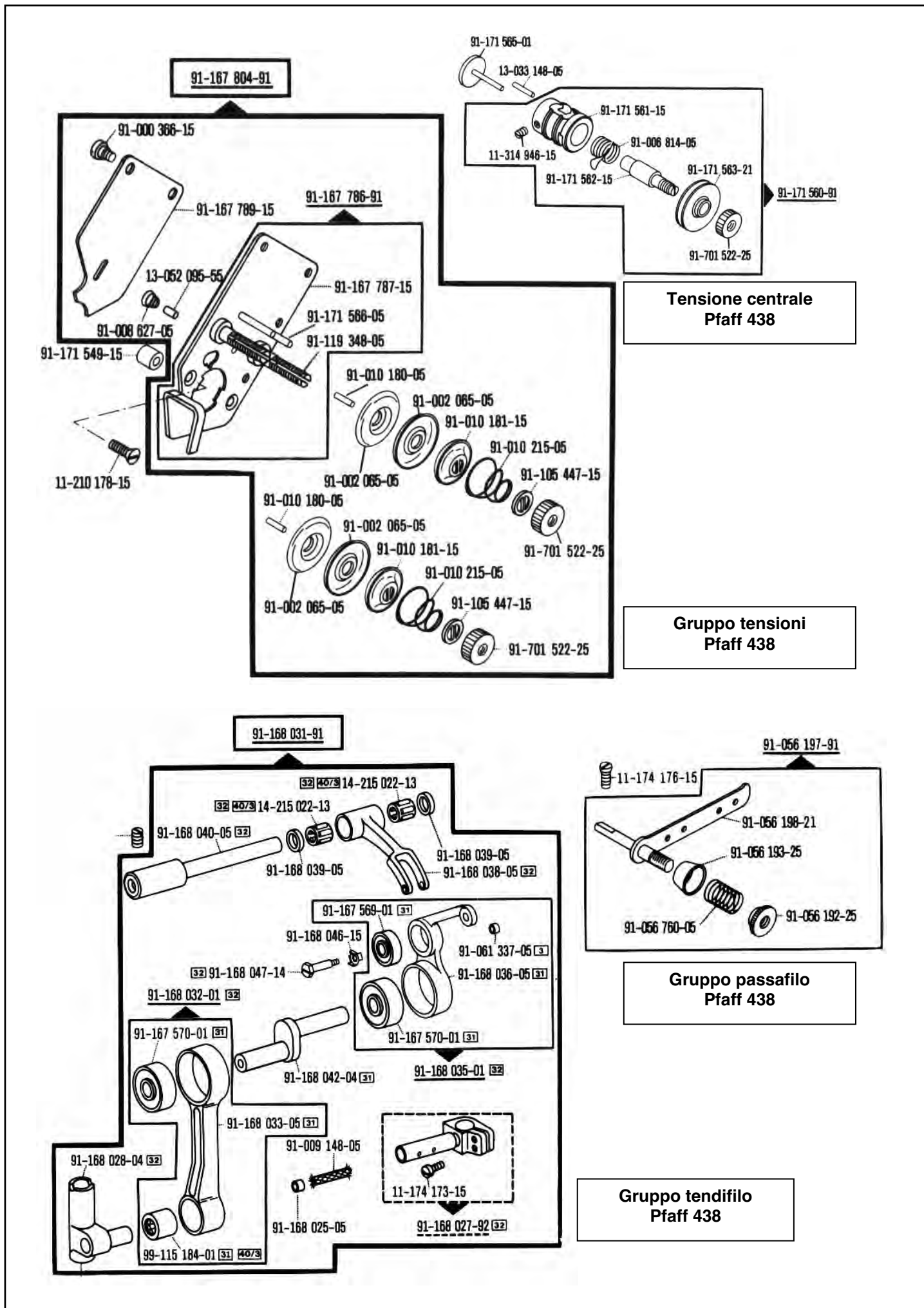











## VITI VARIE

### PFAFF

|   |   |   |  |
|---|---|---|--|
|  | 11-174086-15 (700288) vite ago cl. 145; 146; 335              |  | 91-000509-15 (509)                               |
|  | 11-330085-15 (330085) vite ago cl. 481; 483                   |  | 91-000785-05 (785)                               |
|  | 91-000034-15 (34P) vite piedino cl. 145; 146; 335             |  | 91-001179-15 (1179) vite ago cl. 463; 481; 483   |
|  | 91-000073-35 vite piedino cl. 463; 483                        |  | 91-100296-35 (296-35) vite placca cl. 481; 483   |
|  | 91-000219-15 (219P)   |  | 91-700112-25 (700112) vite per guide             |
|  | 91-000407-15 (407-15) vite griffa cl. 145; 146; 242; 463; 483 |  | 91-700868-15 (700868) vite ago cl. 138; 238; 438 |
|  | 91-000422-25 (422-25) vite placca cl. 145; 146; 242           |  | 91-700991-15 (700991)                            |
|  | 91-000422-35 (422) vite placca cl. 463                        |  | 91-701344-35 (701344)                            |

### RIMOLDI

|   |                            |   |                              |
|---|----------------------------|---|------------------------------|
|    | 202488-0-10 vite griffa    |    | 741413-0-00                  |
|    | 202489-0-10 vite griffa    |    | 741433-0-00 taglia catenella |
|    | 202496-0-10 vite clt. sup. |    | 744742 0-00 vite placca      |
|    | 204947-0-10                |   | 745800-2-00 vite ago         |
|  | 740236-0-00 vite guide     |  | 745812-2-00 crochet inf.     |

### SINGER

|   |                      |   |                                |
|---|----------------------|---|--------------------------------|
|  | 190 - Vite piedino   |  | 284 Vite per guide             |
|  | 208 - Vite griffa    |  | 51381 - Vite slitteria         |
|  | 286 - Vite per guida |  | 51403 - Vite slitteria         |
|  | 691 - Vite placca    |  | 140239 - Vite ago              |
|  | 857 - Vite ago       |  | 201148 - Vite piastrina posiz. |
|  | 1198 - Vite coltello |  | 500256 - Vite piedino          |
|  | 1318 - Vite cam      |   |                                |

### YAMATO

|   |                              |
|---|------------------------------|
|  | 3637 - Vite ago              |
|  | 3638 - Vite crochet          |
|  | 4404 - Vite taglia catenella |
|  | 5401 - Vite placca           |

**VEDI ANCHE:  
RICAMBI DURKOPP-NECCHI  
SINGER-PFAFF- JUKI- ecc.**